

**Meeting the ongoing  
European customer  
requirements for fruit  
exports**

Andrew Dick  
Australian Fresh Fruit Company Pty  
Ltd (AFFCO)

Project Number: MT06050

## **MT06050**

This report is published by Horticulture Australia Ltd to pass on information concerning horticultural research and development undertaken for the apple & pear, summerfruit and vegetable industry.

The research contained in this report was funded by Horticulture Australia Ltd with the financial support of Australian Fresh Fruit Company Pty Ltd (AFFCO).

All expressions of opinion are not to be regarded as expressing the opinion of Horticulture Australia Ltd or any authority of the Australian Government.

The Company and the Australian Government accept no responsibility for any of the opinions or the accuracy of the information contained in this report and readers should rely upon their own enquiries in making decisions concerning their own interests.

ISBN 0 7341 1880 5

Published and distributed by:  
Horticulture Australia Ltd  
Level 7  
179 Elizabeth Street  
Sydney NSW 2000  
Telephone: (02) 8295 2300  
Fax: (02) 8295 2399  
E-Mail: [horticulture@horticulture.com.au](mailto:horticulture@horticulture.com.au)

© Copyright 2008



*Know-how for Horticulture™*

## **Final Report**

**Milestone Number: 190**

**HAL Project Number: MT06050**

**Meeting the ongoing European customer requirements for fruit exports**

**Project Leader: Andrew Dick**

**Research Provider: Jane Lovell (TQA)**

**HAL Project Number: MT06050**

**Milestone Number: Final report**

**Meeting the ongoing European customer requirements for fruit exports**

**Project Leader:** Andrew Dick  
Australian Fresh Fruit Company Pty Ltd  
PO Box 363, Gisborne, Vic 3437  
Ph 03 54207444 Fax 03 54207447  
Email andrewd@affco.com.au

**Key personnel:** Jane Lovell, Tasmanian Quality Assured Inc  
Tundra Howe, Tasmanian Quality Assured Inc

**Organisation:** Australian Fresh Fruit Company Pty Ltd  
PO Box 363  
Gisborne Vic 3437

**Statement:** This report to Horticulture Australia Ltd, builds on the earlier EurepGAP Project AP03023, and investigates Quality Assurance certification and compliance for Australian Pink Lady™ and Sundowner™ apples and other fruits so that this is not an impediment to commercial market access for export to Europe.

**Acknowledgement:** Thank you to the AFFCO support team for managing the details and the project leaders Jane Lovell and Tundra Howe who have diligently supported the work over the years.

**Date:** 30 September 2008

**Disclaimer:** Any recommendations contained in this publication do not necessarily represent current HAL policy. No person should act on the basis of the contents of this publication, whether as to matters of fact or opinion or other content, without first obtaining specific, independent professional advice in respect of the matters set out in this publication.

## Table of Contents

1	Media summary .....	2
1.1	Meeting the ongoing European customer requirements for fruit exports	2
1.1.1	Key components of the project were: .....	2
1.1.2	Key outcomes of the project were: .....	2
1.1.3	Recommendations for future research and development:.....	2
1.1.4	Recommendations for practical application to industry: .....	2
2	Technical summary.....	3
2.1	Key activities and achievements of the project:	3
2.1.1	Aim .....	3
2.1.2	Activity .....	3
2.2	Report and Outputs	6
2.3	Outcomes	6
3	Introduction .....	7
3.1	Background	7
3.2	Aim	7
4	Materials and Methods .....	8
4.1	Method	8
5	Results.....	14
5.1	Report and Outputs	14
5.2	Outcomes	14
6	Technology Transfer.....	14
7	Discussion and Recommendations .....	155
	Appendix 1 – Summary of changes from EurepGAP Version 2 to GlobalGAP Version 3.....	16
	Appendix 2 - GlobalGAP Training Manual - extract .....	17
	Appendix 3 – GlobalGAP Presentation — November 2008.....	28

# **1 Media summary**

## **1.1 Meeting the ongoing European customer requirements for fruit exports**

The GlobalGap Project audited Quality Assurance (QA) certification and compliance for Australian Pink Lady™ and Sundowner™ apples and other fruits so that QA was not an impediment to commercial market access for export to Europe, in particular the United Kingdom.

This project was significant to growers and packers as they now have access to the latest Quality Assurance (QA) certification support and QA compliance will not be an impediment to commercial market access in Europe.

### **1.1.1 Key components of the project were:**

- to ensure that packing sheds were fully compliant with the needs of customers and in particular the British Retail Consortium Global Standard – Food and other retailer specific standards, in particular Marks & Spencer Field to Fork standard.
- Communication of an updated GlobalGAP interpretive manual template to assist Australian growers to address the new GlobalGAP compliance criteria to stakeholders.
- Project expansion – manuals were developed which were also suitable for growers of pears, stonefruit and cherries as well as other products where there was a demand for the manual.
- Strong communication of the project and its ability to assist all stakeholders in the Pink Lady™ export value chain from grower to consumer.

### **1.1.2 Key outcomes of the project were:**

- QA compliance has not been a barrier to trade for growers of Australian Pink Lady™ and Sundowner™ apples destined for export to UK/Europe.
- All currently certified growers and packers meet the needs of the revised GlobalGAP, BRC system and/or retailer specific programs.
- Growers of other fruits have used the manuals to assist their certification process.

### **1.1.3 Recommendations for future research and development:**

This project successfully achieved the aim of helping growers meet the needs of overseas buyers. The fact that Australian exports account for a small percentage of total production means that growers and exporters will continue to require support. Over the duration of this project and its predecessor, specific market requirements continue to evolve. Future projects will need to continue to track changes and adapt systems which can be implemented under Australian conditions, in particular use of a multiple auditing tool

### **1.1.4 Recommendations for practical application to industry:**

This has been a practical project – the challenge going into the future will be to continually simplify overseas requirements so that growers can implement in line with current QA procedures such as SQF 2000™, Freshcare™ and domestic retailer systems.

## 2 Technical summary

For many years the European (in particular the UK) consumer and therefore the supermarkets, have led the way in terms of environmental and food safety demands and the consequent need for system certification for fresh produce.

To address the need for certification to the EurepGAP Protocol and the British Retail Consortium (BRC) Global Standard – Food, and to assist growers of Pink Lady apples to meet UK customer requirements, Project AP03023 successfully developed a manual template to assist Australian growers to address the EurepGAP compliance criteria (major musts, minor musts and recommendations). In addition, the project simplified the process to enable many growers to achieve certification by working in commercially-related regional groups and created the opportunity for group certification at a considerable cost saving.

The project was then extended to assist packers to meet the needs of the BRC pack house certification scheme and to synchronise growers' EurepGAP manuals with retailers' in-house schemes (such as Marks and Spencer's Field to Fork program and Tesco's Nature's Choice).

Project MT06050 was undertaken by AFFCO to ensure the on-going funding of the EurepGAP (now known as GlobalGAP) project to enable the abovementioned manual template to be updated:

1. to accommodate advances made to our knowledge base on issues such as microbial contamination and risk assessment;
2. to incorporate the 2007 revision of GlobalGAP and Maximum Residue Limit (MRL) changes; and
3. for further development for growers of other horticultural crops.

### 2.1 Key activities and achievements of the project:

#### 2.1.1 Aim

To ensure that packing sheds were fully compliant with the needs of customers, the project aimed to assist packing sheds to meet the specific customer needs in this area. The previous project carried out a mapping exercise for a number of sheds and this was extended to carrying out a mock BRC audit and helping packing sheds meet the specific requirements of Marks & Spencer's Field to Fork scheme.

The project coordinator carried out amendments to the EurepGAP template manual, made the necessary changes to the grower manuals and carried out regional visits to communicate the changes. The project leader also assisted growers to fully comply with programs such as M&S to Field to Fork program and Tesco's Nature's Choice.

Attendance at the EurepGAP Conference and meeting with importers, retailers, distributors and other producer bodies enhanced the accuracy, timeliness and relevance of the information.

#### 2.1.2 Activity

##### a) European Market visits and GlobalGAP conference - 2006

In September 2006 Jane Lovell and Tundra Howe from TQA Inc travelled to the UK to visit importers of Pink Lady™ apples, to attend a SHAFTE meeting on behalf of Horticulture Australia Limited and the EurepGAP Conference. Importers identified a number of requirements Australian suppliers need to comply with to gain entry to the UK Market.

The minimum requirements for growers were:

- EurepGAP/ GlobalGAP
- Field to Fork / Natures Choice (if supplying to Marks and Spencer or Tesco respectively)
- Sedex

For pack houses the requirements were:

- BRC (British Retail Consortium Global Standard - Food) – particularly if the pack house is a direct supplier and using branded packaging
- Field to Fork / Natures Choice (if supplying to Marks and Spencer or Tesco respectively)
- Sedex

In addition to the above, each representative had his or her own idea of other programs / standards that may become requirements in the future. These included:

- ETI (Ethical Trade Initiative) Audits
- Other environmental programs such as LEAF (Linking Environment And Farming) and Carbon Foot printing / Food Miles
- Additional pesticide requirements

For the minimum requirements listed above for both grower and pack houses the deadline has passed. Compliance to these standards is already a minimum requirement of supply.

#### SHAFFE meeting

On the European visit Jane Lovell and Tundra Howe also attended the SHAFFE (Southern Hemisphere Association of Fresh Fruit Exporters) meeting prior to the EurepGAP *Event for Revision and Implementation 2007* Conference. TQA attended the meeting to represent Horticulture Australia Limited and the Australian perspective on proposed changes to EurepGAP, particularly proposed fee increases.

The major issues raised by the representatives at the meeting were:

- No international harmonisation of MRL's
- More transparency in regards to fees and what they are used for
- Database confidentiality
- Fee structure
- Good retailer practices

From this meeting, a letter to the EurepGAP Board was drafted outlining these issues, and was read by John-Francois Proust during question and answer time on Day 2 of the Conference. This was later produced as a press release.

#### EurepGAP Event for Revision and Implementation 2007 Conference

The Conference was attended by over 270 delegates from 41 countries. Attendance at the conference had a two-fold benefit – firstly the TQA representatives were able to gain feedback on proposed new changes and secondly they were able to influence some changes which increased suitability to Australian conditions

#### **b) Amendment to GlobalGAP standard**

During the course of the project TQA amended the GlobalGAP standard – this took into account the changes and the interpretations that were made and understood as a result of the attendance at the EurepGAP conference.

The CD of the manual has been produced for distribution to Pink Lady export members and has also been made available to growers of other crops including cherries, stone fruit and vegetables – through the TQA connection with the vegetable industry in northern Tasmania.



**c) Specific retailer programs – Field to Fork**

The major requirement for specific retailer programs has been from Marks and Spencer. Whilst the Pink Lady export program has aimed to embrace Tesco – in reality in the specific years relating to this program – M&S has been the key target market for Australian product.

Details of the standard and auditing requirements were obtained by the TQA team. Utilising some proprietary software (Muddy Boots) which AFFCO purchased – the TQA set about training WA growers to be able to meet the M&S standard. Over the course of the last 3 years TQA has visited growers in WA to help them meet the standard in the most cost effective standard. Additionally TQA have attended auditor training in the UK to further enable them to assist growers meet the stringent M&S standard.

The fact that the project has been able to help growers meet this standard has been an outstanding success for the project.

**d) Regional visits**

As indicated above visits have been undertaken to a number of regions during the course of the project. The visits have had to purposes:

- 1) To address audiences in a general sense on the update of the project, the latest information on QA systems and GlobalGAP in general
- 2) To specifically work with growers in each region

During the course of the project most major districts involved in the project have been visited

**e) Presentations**

Presentations were made by Jane Lovell as part of the PLA Ltd road show in November 2007 – the well attended meetings were held in Donnybrook (WA), Adelaide Hills (Lenswood, SA) and Tatura, Vic (DPI).

Jane Lovell and Tundra Howe also participated in the IHD AFFCO Expo in May 2008 with Tundra presenting three 1.5 hour workshops as part of the concurrent workshop program.

Key messages from those that attended the workshop were:

- Growers continue to be confused over which QA / food safety standard to choose
- There is ongoing frustration as growers continue to be subjected to multiple audits, which in turn result in high auditing costs
- Growers recognise compliance to an environmental standard is on the horizon, and are fearful that this will go the way of QA – multiple standards required by different customers, rather than one standard for all, or a way of benchmarking standards against each other

In January 2008 Jane Lovell was involved in a workshop initiated by PLA Ltd to address the technical impediments to Pink Lady exports.

**f) Working with growers and packers**

Over the course of the three years – Jane Lovell and/ or Tundra Howe have visited the following regions on a number of occasions:

1. Manjimup/ Donnybrook WA
2. Adelaide Hills, SA  
Goulburn Valley, Vic
3. Batlow

During those visits – they have liaised with groups or individual growers and packers to assist them achieve GlobalGAP certification, help them gain Field to Fork certification and/ or carry out a mock audit of BRC (British Retail Consortium) packing shed standard.

As part of the project the TQA team has liaised with the Pink Lady export coordinator to help new entrants gain approval to be a supplier to a specific importer. It has been agreed to map out a process for dealing with new export entrants. This can result in the importer gaining supply but also the knowledge that a process is in place to ensure long term program integrity

#### **g) Software**

In late January of 2007, following the UK visit, AFFCO purchased the Quickfire® software program from Muddy Boots. This has been installed on Tundra Howe's computer, the AFFCO server and training carried out.

The actual implementation has proved more difficult than expected as a result of set-up issues with the importer in the UK. It is hoped that this can be better utilized in the future as the POTENTIAL to have a program which can map out and help a grower or packer achieve multiple certification requirements is a goal worth having

As can be seen from the summary analysis below this project has successfully met its primary objective of their being no QA barrier to access for Australian Pink Lady apples in export markets. The program has been well delivered by the TQA team who has helped a number of growers and packers successfully achieve QA market requirements.

The only disappointment for the project has been the difficult market conditions encountered by Australian Pink Lady apples in the UK market. This has primarily resulted from drought conditions in Australia and a major post harvest issue in Western Australia.

## **2.2 Report and Outputs**

Outputs:

- Updated GLOBALGAP manuals reflecting changes to standard – *manuals changed*
- Mapping process for new GLOBALGAP Protocol to retailer specific programs – *strong focus on achieving Field to Fork certification*
- Notes for registered sheds of how to comply with BRC – *mock audits held with packing sheds; no major demand for BRC*
- Manual changes reflecting the needs of pear, stone fruit and cherry growers and other fruits by demand – *manual changes on GlobalGAP suitable for a variety of fruits*
- Workshop for auditors – agreement reached with major audit company to carry out
- Presentation for regional workshops – *several presentations made*
- Presentation at Pink Lady Australia AGM – *presentations made at each PLA AGM*

## **2.3 Outcomes**

- QA compliance will not be a barrier to trade for growers of Pink Lady and Sundowner destined for export to UK/Europe – *the project has successfully resulted in QA compliance providing no barrier to trade for Australian growers. It does have to be said that compliance cost has been raised as an issue and this has been partially addressed by the organization of a group deal with a specific audit company*
- All currently certified growers and packers meet the needs of the revised GlobalGAP, BRC system and/or retailer specific programs – *growers have successfully updated their manuals to reflect the requirements of their specific customer*

- Growers of other fruits have used the manuals to assist their certification process – *Growers of other fruits have successfully used the manual*

### **3 Introduction**

#### **3.1 Background**

For many years the European (in particular the UK) consumer and therefore the supermarkets, have led the way in terms of environmental and food safety demands and the consequent need for system certification for fresh produce.

To address the need for certification to the EurepGAP Protocol and the British Retail Consortium (BRC) Global Standard – Food, and to assist growers of Pink Lady apples to meet UK customer requirements, Project AP03023 successfully developed a manual template to assist Australian growers to address the EurepGAP compliance criteria (major musts, minor musts and recommendations). In addition, the project simplified the process to enable many growers to achieve certification by working in commercially-related regional groups and created the opportunity for group certification at a considerable cost saving.

The project was then extended to assist packers to meet the needs of the BRC packhouse certification scheme and to synchronise growers' EurepGAP manuals with retailers' in-house schemes (such as such as Field to Fork for Mark's and Spencer and Nature's Choice for Tesco).

Project MT06050 was undertaken by AFFCO to ensure the on-going funding of the EurepGAP (now known as GlobalGap) project to enable the abovementioned manual template to be updated:

1. to accommodate advances made to our knowledge base on issues such as microbial contamination and risk assessment;
2. to incorporate the 2007 revision of GlobalGap and Maximum Residue Limit (MRL) changes; and
3. for further development for growers of other horticultural crops.

An issue for growers that was identified in a recent Pink Lady Australia Roadshow following a disastrous season was that 'export is too difficult' and carried risks associated with achieving MRL's, quality compliance, different retailer demands etc. This issue demonstrated why this project was so crucial in preserving the EurepGAP concept and work to date now known as GlobalGap.

#### **3.2 Aim**

The aim of this project was to ensure:

1. that growers and packers had access to the latest Quality Assurance (QA) certification support; and
2. that QA compliance was not an impediment to commercial market access in Europe for export of Australian Pink Lady™ and Sundowner™ apples and other fruits.

This was achieved by engaging the services of a specialist QA consultant with appropriate experience with UK/European generic and proprietary QA systems. The consultant worked with groups of growers and packers in regional and commercially related groups, to ensure that systems met the certification requirements of the applicable schemes. The consultant convened workshops of Australian auditors accredited to certify to these standards to ensure that there was a common understanding of the compliance criteria. The outcome of this work will be compliance of growers and packers to the applicable QA standard/s and ongoing commercial market access to this valuable market.

Pink Lady exports have provided one of the few opportunities for Australian apple growers to generate a profitable return. Ongoing participation in an export program will be critical for export profitability in itself, as well as ensuring a healthy domestic market that is not flooded with fruit that could and would be otherwise exported. This project has assisted growers export at a lower cost because of consistent QA implementation and audit arrangements and at the same time meet overseas customer compliance requirements. The QA compliance IP has been revised, updated and extended to other fruit and vegetable crops where compliance with customer QA requirements is a commercial barrier to access. A recent Roadshow and AFFCO Survey identified cost and market QA requirements as key impediments to export.

## 4 Materials and Methods

### 4.1 Method

This project was divided into a number of activities as follows:

- |   |   |
|---|---|
| <b>1. Helping packhouses meet EU customer needs</b> | <b>Aim</b><br>To ensure that packing sheds were fully compliant with the needs of customers, the project aimed to assist packing sheds to meet the specific customer needs in this area. The previous project carried out a mapping exercise for a number of sheds and this was extended to carrying out a mock BRC audit and helping packing sheds meet the specific requirements of Marks & Spencer's Field to Fork scheme. |
| <b>2. Helping growers meet EU customer needs</b>    |   |

The project coordinator carried out amendments to the EurepGAP template manual, made the necessary changes to the grower manuals and carried out regional visits to communicate the changes. The project leader also assisted growers to fully comply with programs such as M&S Field to Fork program and looked at Tesco's Nature's Choice.

Attendance at the EurepGAP Conference and meeting with importers, retailers, distributors and other producer bodies enhanced the accuracy, timeliness and relevance of the information.

#### Activity

##### a. European Market visits and GlobalGAP conference - 2006

In September 2006 Jane Lovell and Tundra Howe from TQA Inc travelled to the UK to visit importers of Pink Lady<sup>tm</sup> apples, to attend a SHAFFE meeting on behalf of Horticulture Australia Limited and the EurepGAP Conference. A trip report was provided and key outcomes are detailed below.

#### Importer meetings

Meetings were held with 6 key importers of Pink Lady apples (some of whom are involved in import of other Australian produce);

- Mack Multiples
- Worldwide Fruit
- Empire World Trade
- Chingford (AG Thames)
- JP Fruit Distributors Limited
- Orchard World

Importers identified a number of requirements Australian suppliers need to comply with to gain entry to the UK Market.

The minimum requirements for growers were;

- EurepGAP/ GlobalGAP
- Field to Fork / Natures Choice (if supplying to Marks and Spencer or Tesco respectively).
- Sedex

For packhouses the requirements were;

- BRC (British Retail Consortium Global Standard - Food) – particularly if the packhouse is a direct supplier and using branded packaging.
- Field to Fork / Natures Choice (if supplying to Marks and Spencer or Tesco respectively).
- Sedex

In addition to the above, each representative had his or her own idea of other programs / standards that may become requirements in the future. These included:

- ETI (Ethical Trade Initiative) Audits
- Other environmental programs such as LEAF (Linking Environment And Farming) and Carbon Foot Prints
- Additional pesticide requirements

For the minimum requirements listed above for both grower and pack houses the deadline has passed. Compliance to these standards is already a minimum requirement of supply.

At the time no firm dates were conveyed by importers for the emerging requirements, although opinions were offered. For example, Waitrose supermarkets were due to publish a date for participation in LEAF during the first half of this year. Marks and Spencer would like to achieve “residue-free status” by 2010. During the course of the project the requirements have been refined to a base requirement for GlobalGAP, a preference by some specific supermarkets eg Field to Fork for Marks and Spencer which has been a major focus for this project.

#### SHAFFE meeting

On the European visit Jane Lovell and Tundra Howe also attended the SHAFFE (Southern Hemisphere Association of Fresh Fruit Exporters) meeting prior to the EurepGAP *Event for Revision and Implementation 2007* Conference. TQA attended the meeting to represent Horticulture Australia Limited and the Australian perspective on proposed changes to EurepGAP, particularly proposed fee increases.

The major issues raised by the representatives at the meeting were:

- No international harmonisation of MRL's
- More transparency in regards to fees and what they are used for
- Database confidentiality
- Fee structure
- Good retailer practices

From this meeting, a letter to the EurepGAP Board was drafted outlining these issues, and was read by John-Francois Proust during question and answer time on Day 2 of the Conference. This was later produced as a press release.

The issue of harmonisation of MRL's has been an important one for the Pink Lady export program. This has been addressed through a number of supplementary projects including AP6023.

*EurepGAP Event for Revision and Implementation 2007 Conference*

The Conference was attended by over 270 delegates from 41 countries. TQA representatives were the only Australian delegates. The event was a combination of a workshop to discuss the proposed changes to EurepGAP and a formal Conference.

With regard to the proposed changes to EurepGAP, delegates were given the opportunity to access a copy of the draft 2007 EurepGAP Standard a few days prior to the workshop. The proposed changes to the standard were discussed and debated in a series of round table sessions. It was most fortuitous that Australian representatives were in attendance as it became apparent that many of the other delegates had no first-hand experience implementing or "living with" EurepGAP. It was also apparent that many of the larger corporate farms are utilising the "Grower Group" certification option and significantly reducing the workload and costs to their growers. Some of the proposed changes would have disadvantaged Australian producers and were strenuously argued against. A number of interpretations were modified as a result of the Australian input, including a revision of the requirements for recycled water. Details of the proposed changes to the standard and Conference was included in a trip report and the major feedback has been incorporated into the project which is reflected in this final report.

**b. Amendment to GlobalGAP standard**

During the course of the project TQA amended the GlobalGAP standard – this took into account the changes and the interpretations that were made and understood as a result of the attendance at the EurepGAP conference.

One of the changes to EurepGAP was the renaming of the standard to GlobalGAP.

The EurepGAP interpretive manual, written by Jane Lovell from TQA, was updated by Tundra Howe to reflect the changes to the standard, and has been renamed the 'GlobalGAP Interpretive Manual'.

The standard has been split into a number of modules (titled "Integrated Farm Assurance"). There are now three modules for fruit growers to comply with – 'All Farm Base', 'Crops Base', and 'Fruit and Vegetables'. Within the standards, there are a number of new Control Points, particularly relating to Worker Health and Safety. A number of the existing elements have had a rise in compliance level i.e. an individual

element may have changed from 'minor' to 'major'.

Some specific changes to the standard include the requirement for growers to:

- Implement re-entry procedures into areas where chemicals have been applied
- Complete risk assessments for safe and healthy working conditions for tasks completed on farm
- Ensure all employees have been adequately trained in OHS on farm
- Retain information on all employees and subcontractors including full names and employment conditions
- Complete a self assessment on all contractors working on farm
- Develop and implement procedures for cleaning of personal protective equipment
- Monitor energy use
- Document a recall procedure and test it on an annual basis

The re-write of the GlobalGAP Interpretive Manual incorporated all these changes and provided example procedures and forms growers could use to comply with these new elements and changes.

A summary of the changes to the GlobalGAP standard has been included in the appendix of this report.

The CD of the manual has been produced for distribution to Pink Lady export members and has also been made available to growers of other crops including cherries, stone fruit and vegetables – through the TQA connection with the vegetable industry in northern Tasmania.

### **c. Specific retailer programs – Field to Fork**

The major requirement for specific retailer programs has been from Marks and Spencer. Whilst the Pink Lady export program has aimed to embrace Tesco – in reality in the specific years relating to this program – M&S has been the key target market for Australian product.

In March 2007 senior representatives of Tesco visited Australia and toured the Batlow district. They were most impressed with effort that the PLA export program had gone to with respect to accreditation.

During the visit to the UK TQA representatives familiarised themselves with the requirements of M&S Field to Fork system of certification which is specific to M&S and was launched in 2005/6.

Details of the standard and auditing requirements were obtained by the TQA team. Utilising some proprietary software (Muddy Boots) which AFFCO purchased – TQA set about training WA growers to be able to meet the M&S standard. Over the course of the last 3 years TQA has visited growers in WA to help them meet the standard in the most cost effective standard. Additionally TQA have attended auditor training in the UK to further enable them to assist growers meet the stringent M&S standard.

The fact that the project has been able to help growers meet this standard has been an outstanding success for the project.

**d. Regional visits**

As indicated above visits have been undertaken to a number of regions during the course of the project. The visits have had two purposes:

1. To address audiences in a general sense on the update of the project, the latest information on QA systems and GlobalGAP in general
2. To specifically work with growers in each region

During the course of the project most major districts involved in the project have been visited

An additional linkage was organizing for Lindi Benic (Deciduous Fruit Producers' Trust, South Africa and SHAFFE representative) to visit the Adelaide Hills following her presentation to the *Keep It Real* Conference in Hobart in August 2007.

**e. Presentations**

Presentations were made by Jane Lovell as part of the PLA Ltd road show in November 2007 – the well attended meetings were held in Donnybrook (WA), Adelaide Hills (Lenswood, SA) and Tatura, Vic (DPI).

Jane Lovell and Tundra Howe also participated in the IHD AFFCO Expo in May 2008 with Tundra presenting 3 1.5 hour workshops as part of the concurrent workshop program.

Key messages from those that attended the workshop were:

- Growers continue to be confused over which QA / food safety standard to choose
- There is ongoing frustration as growers continue to be subjected to multiple audits, which in turn result in high auditing costs
- Growers recognise compliance to an environmental standard is on the horizon, and are fearful that this will go the way of QA – multiple standards required by different customers, rather than one standard for all, or a way of benchmarking standards against each other.

In January 2008 Jane Lovell was involved in a workshop initiated by PLA Ltd to address the technical impediments to Pink Lady exports.

**f. Working with growers and packers**

Over the course of the 3 years – Jane Lovell and/ or Tundra Howe have visited the following regions on a number of occasions:

- Manjimup/ Donnybrook WA
- Adelaide Hills, SA  
Goulburn Valley, Vic
- Batlow

During those visits – they have liaised with groups or individual growers and packers to assist them achieve GlobalGAP certification, help them gain Field to Fork certification and/ or carry out a mock audit of BRC (British Retail Consortium) packing shed standard.



As part of the project the TQA team has liaised with the Pink Lady export coordinator to help new entrants gain approval to be a supplier to a specific importer. It has been agreed to map out a process for dealing with new export entrants. This can result in the importer gaining supply but also the knowledge that a process is in place to ensure long term program integrity

**g. Software**

In late January of 2007, following the UK visit, AFFCO purchased the Quickfire® software program from Muddy Boots. This has been installed on Tundra Howe's computer, the AFFCO server and training carried out.

The actual implementation has proved more difficult than expected as a result of set-up issues with the importer in the UK. It is hoped that this can be better utilized in the future as the POTENTIAL to have a program which can map out and help a grower or packer achieve multiple certification requirements is a goal worth having.

**3. Auditor training**

The project leader originally intended to carry out an annual auditor training day. However, the program leader identified opportunities to reduce overall compliance costs through the facilitation of discussions between auditors and grower groups. In the last year of the project the project helped facilitate a certification company to put forward a "group" deal which could significantly reduce the cost of certification.

This can help address a major barrier to export – the cost of GlobalGAP certification.

**4. Communication**

Communication of the updated manual and the progress of the project has been an essential part of project and included:

- A number of articles in Tree Fruit Australia/ Australian Fruit Grower of the course of the project
- Regular articles on the project in the AFFCO and Pink Lady Australia newsletters
- Presentations at grower meetings in at least three regions
- Annual presentation at Pink Lady Australia AGM and presentations at AFFCO AGM

**5. Project expansion**

In response to growing demand for a common system and approach, and to reduce costs for growers, the project developed manuals which were suitable for growers of pears, stonefruit and cherries as well as other products where there was a demand for the manual.

**6. Project management and administration**

AFFCO undertook a project management role to ensure the smooth running of the project, good grower contact and feedback from the market place. In this role, AFFCO prepared and submitted milestone reports and carried out all accounting requirements.

As part of the smooth running of the project the TQA and AFFCO teams met up on 2 occasions to plan the project – the result of this was improved communication between the new PLA coordinator, Neil Offner and the TQA team.

## 5 Results

As can be seen from the summary analysis below this project has successfully met its primary objective. The program has been well delivered by the TQA team which has helped a number of growers and packers successfully achieve QA market requirements.

The only disappointment for the project has been the difficult market conditions encountered by Australian Pink Lady™ apples in the UK market. This has primarily resulted from drought conditions in Australia and a major post harvest issue in Western Australia and has resulted in the overall volume projections of the Pink Lady™ export program being met in the last two years.

A summary of the performance of the project against key outputs and outcomes is provided below:

### 5.1 Report and Outputs

Outputs:

- Updated GLOBALGAP manuals reflecting changes to standard – *manuals changed*
- Mapping process for new GLOBALGAP Protocol to retailer specific programs – *strong focus on achieving Field to Fork certification*
- Notes for registered sheds of how to comply with BRC – *mock audits held with packing sheds; no major demand for BRC as this was covered by Field to Fork certification in many instances.*
- Manual changes reflecting the needs of pear, stonefruit and cherry growers and other fruits by demand – *manual changes on GlobalGAP suitable for a variety of fruits*
- Workshop for auditors – *agreement reached with major audit company*
- Presentation for regional workshops – *several presentations made*
- Presentation at Pink Lady Australia AGM – *presentations made at each PLA AGM*

### 5.2 Outcomes

- QA compliance will not be a barrier to trade for growers of Pink Lady and Sundowner destined for export to UK/Europe – *the project has successfully resulted in QA compliance providing no barrier to trade for Australian growers. It does have to be said that compliance cost has been raised as an issue and this has been partially addressed by the organization of a group deal with a specific audit company*
- All currently certified growers and packers meet the needs of the revised GlobalGAP, BRC system and/or retailer specific programs – *growers have successfully updated their manuals to reflect the requirements of their specific customer*
- Growers of other fruits have used the manuals to assist their certification process – *growers of other fruits have successfully used the manual*

## 6 Technology Transfer

As indicated in Section 4, communication of the updated manual and the progress of the project has been an essential part of project and included:

- A number of articles in Tree Fruit Australia/ Australian Fruit Grower of the course of the project
- Regular articles on the project in the AFFCO and Pink Lady Australia newsletters
- Presentations at grower meetings in at least three regions
- Annual presentations at Pink Lady Australia AGM and presentations at AFFCO AGM
- Technology transfer occurring on telehookups, through 1-on-1 contact between the PLA coordinator, TQA staff and growers/ packers and exporters

- There has also been considerable communication between the project staff and importer and retailer technical staff

## **7 Discussion and Recommendations**

It is pleasing to report another successful delivery of a project aimed at helping the profitability of Australian growers. This project has successfully built on the initial project which aimed to assist growers become EurepGAP-ready. This project dealt with a more sophisticated market looking for specific retailer requirements.

Further work will still be required in the future. In November 2007, Pink Lady Australia Ltd developed a plan to further expand the number of growers involved in export. This project has assisted the first stage of this process but in the next two years with the particular threat of apple imports, it is likely that more new growers will become involved from areas such as Batlow, Goulburn Valley, Orange, Stanthorpe and Southern Victoria.

With the intention of re-expanding the export volumes – the project may well need to pursue Tesco's Nature's Choice program and carry out on-going support of current export growers. As can be seen from feedback given by those who attended the GlobalGAP workshop in Shepparton, growers see that environmental standards are on the horizon. This highlights the importance of being proactive in this area

The project should now utilise its experience with development of the updated GlobalGAP interpretive manual to further support growers of other export fruits such as cherries, stonefruit and other crops

## 8 Appendix

### Summary of changes from EurepGAP Version 2 to GlobalGAP Version 3

	<b>OLD – Version 2</b>	<b>NEW - Version 3</b>
Name	EurepGAP	GLOBALGAP
Standard	One standard <i>Fruit and Vegetables</i>	Three modules <i>All Farms Base</i> <i>Crops Base</i> <i>Fruit and Vegetables</i>
Major Control Points	49	74
Minor Control Points	99	125
Recommended Control Points	66	37
Total Control Points	214	236

#### 8.1.1 Level changes

<b>Original Level</b>	<b>New Level</b>	<b>Number</b>
Recommended	Minor	21 Control Points
Recommended	Major	2 Control Points
Minor	Major	7 Control Points

#### 8.1.2 New Sections

Traceability  
Integrated Pest Management

#### 8.1.3 New sub-headings

Subcontractors  
Energy Efficiency  
Sowing / Planting  
Nutrient Requirements  
Final Produce Packing at Point of Harvest  
Personal Hygiene  
Quality Control  
Rodent and Bird Control

#### 8.1.4 Deleted Control Points

1 minor  
6 recommended



# GLOBALGAP Training Manual

## Fruit and Vegetables

Based on Control Points and Compliance Criteria Integrated Farm Assurance – All Farm  
Version 3.0-1 Jul-07

Training manual based on Interpretive Manual created for Webster Fresh and Pink Lady Australia, with funding from HAL, AFFCo, Pink Lady Australia and Webster Fresh and the support of APAL.



# Table of Contents

<b>Introduction .....</b>	<b>3</b>
Interpretation .....	3
Compliance Criteria.....	4
General information.....	5
Staggered implementation .....	5
Standard structure.....	5
<b>Fruit and Vegetables.....</b>	<b>6</b>
FV.2 Soil and Substrate Management .....	6
FV.3 Irrigation / Fertigation.....	10
FV.4 Harvesting.....	11
FV.5 Produce Handling .....	28

## **Introduction**

With the assistance of funding from Horticulture Australia Limited and AFFCo, Pink Lady Australia developed manuals and associated documents to assist Pink Lady Australia growers achieve certification to EurepGAP Version 2.0.

These documents were then used under licence to PLA and HAL to create training materials to assist growers supplying Webster Fresh meet the requirements of EurepGAP.

EurepGAP was reviewed in 2006, and the Integrated Farm Assurance modules were officially released in 2007. On-farm implementation of this version is compulsory from 1<sup>st</sup> January 2008. The standard was renamed GLOBALGAP in September 2007.

AFFCo and Webster Fresh co-funded a rewrite of this training manual in 2007. The manual includes the specific requirements of each element of the GLOBALGAP protocol and an explanation of what this means, what has to be done and examples of appropriate records to demonstrate compliance with the element.

The documents must not be copied or further distributed.

## ***Interpretation***

Every attempt has been made to provide sufficient information for growers to successfully achieve GLOBALGAP compliance. However, it is recognised that particular situations may require discussion or further clarification.

NB The original copy of the Internal Audit Checklist for each module must remain on farm as a record required for the external audit.

## Compliance Criteria

The GLOBALGAP protocol has three levels of compliance criteria, Major Musts, Minor Musts and Recommendations.

Major Musts	100% compliance of all applicable 'major musts' is compulsory. A 'major must' not fulfilled leads to suspension of certificate. Corrective action to correct the non-conformance must be verified by the Certification Body (by site visit or by other form of documented verification)
Minor Musts	95% compliance of all applicable 'minor musts' is compulsory. The total is calculated across the three modules, not for each individual module. Where required, corrective action must be verified by the Certification Body (by site visit or by other form of documented verification) within a maximum period of four weeks.
	For the sake of calculation, the following formula applies:
	$\left\{ \begin{array}{l} \text{(Total number of} \\ \text{Minor Musts)} \end{array} - \begin{array}{l} \text{(Not Applicable Minor} \\ \text{Musts scored on farm)} \end{array} \right\} \times 5\% = \begin{array}{l} \text{(Total Minor Musts non-} \\ \text{compliance allowable)} \end{array}$
Recommendations	Recommendation level. These control points must be inspected, but the granting of GLOBALGAP certification/licence is not conditional to their compliance.

In some instances particular control points may be considered Not Applicable to the particular business. For instance, the use of substrates may not be relevant to vegetable production and so control points related to this issue may be marked NA. However, where the Compliance Criteria state "No N/A" this particular control point must be addressed.



## General information

Information regarding GLOBALGAP can be accessed directly from the GLOBALGAP website [www.globalgap.org](http://www.globalgap.org). Details on Control Points and Compliance Criteria as well as General Regulations covering issues relating to compliance levels and certification options are available and it is recommended that participants familiarise themselves with these documents. (Go to website; click on “**The Standard**” on the left hand menu; click on “**Integrated Farm Assurance**”; then select “**Fruit and Vegetables**”.)

The “Guidelines for Implementing EurepGAP for Australian Fresh Fruit and Vegetables” have been used as a major source of information regarding interpretation of requirements.

## Staggered implementation

To assist implementation of GLOBALGAP, the training and documentation is being prepared in three stages, reflecting the three individual modules applicable to vegetable growers. Training and implementation will start with the All Farm Base, and then move to the Crops Base and finally the Fruit and Vegetables module. This approach is not intended to diminish the importance of each module, but rather to assist growers with rapid implementation.

## Standard structure



The Standard has now been split into a number of ‘modules’. All participants are now required to comply with the “All Farm Base” module.

Depending on the scope of certification, the next module will differ if producers are focusing on crops, livestock or aquaculture. In this case, the “Crops Base” module applies.

The final module is determined by what type of product is being produced i.e. cotton, tea, onions. In this case, the “Fruit and Vegetables” module is applicable.

## Fruit and Vegetables

### *FV.2 Soil and Substrate Management*

#### What the GLOBALGAP protocol requires

Nº	CONTROL POINT	COMPLIANCE CRITERIA	LEVEL
<b>FV.2.1 Soil Fumigation (N/A if no soil fumigation)</b>			
FV.2.1.1	Is there a written justification for the use of soil fumigants?	There is written evidence and justification for the use of soil fumigants including location, date, active ingredient, doses, method of application and operator. The use of Methyl Bromide as soil fumigant is not permitted.	Minor
FV.2.1.2	Is any pre-planting interval complied with?	Pre-planting interval must be recorded.	Minor

#### What this means

Soil fumigants should only be used where there is a valid reason for doing so, and no other viable or effective options exist. Where soil fumigation is necessary and applied, records must be maintained of that application and the reason for use.

Product should also be checked to ensure there is no adverse health risk posed by take-up of soil chemicals. There are maximum residue limits (MRLs) or extraneous residue limits (ERLs) for persistent chemicals in most fresh produce. Information on Maximum Residue Limits can be obtained from the Food Standards Code Standard 1.4.2 (MRL's Schedule 1, ERLs Schedule 2) <http://www.foodstandards.gov.au/thecode/>

If the soil fumigant has a pre-planting interval stated on the label, this interval must be complied with, and recorded to provide evidence of compliance (can be compared to the planting details required in the Crops Base module).

A person with the appropriate skills and training must apply soil fumigants according to the label or restricted use permit.

Methyl Bromide as a soil fumigant is not permitted.

#### What you have to do

- Ensure no Methyl Bromide is used as a soil fumigant.
- Where any other soil fumigant is used record:
  - The reasons for fumigation (eg nematode counts etc),
  - Reasons for not using alternatives to chemical fumigants,
  - Application details including location, weather conditions, date, dose, active ingredient and application method, operator;
- Comply with and record any pre-planting intervals

#### Examples of forms

# Soil Fumigation Record

Crop:.....

Date	Variety	Block Id.	Reason / justification for fumigation	Rec. made by	Target	Chemical			Application method	Weather conditions (wind speed & direction)	WHP	Applied by
						Name	Active	Rate				

WHP = Withholding period

## What the GLOBALGAP protocol requires

Nº	CONTROL POINT	COMPLIANCE CRITERIA	LEVEL
<b>FV.2.2 Substrates (N/A if no substrates are used)</b>			
FV.2.2.2	If chemicals are used to sterilise substrates for reuse, have the location, the date of sterilisation, type of chemical, method of sterilisation, name of the operator and pre-planting interval been recorded?	When the substrates are sterilised on the farm, the name or reference of the field, orchard or greenhouse are recorded, if sterilised off farm then the name and location of the company which sterilises the substrate.	Major

### What this means

The section on substrates is only applicable where plants are grown in substances or solutions other than soil, i.e. hydroponics, container grown or greenhouse. It defines and records the way substrates are justified and managed.

If substrates are used, it is recommended that the producer participate in recycling programmes where available. Evidence of this participation could be in the form of invoices or loading dockets. If there is no participation in substrate recycling, the reasons for this non-participation must be justified.

If substrate is sterilised for reuse the location of the sterilisation must be recorded, along with the date, type of chemical used, the method, the name of the operator and any applicable pre-planting intervals.

The block or section of farm (on-site) or sterilising company (off-site) must be identified and recorded.

### What you have to do

- If substrate is sterilised for reuse the details of the sterilisation must be recorded, including:
  - Location
  - Dates of sterilisation;
  - Name of active ingredient;
  - Machinery used;
  - The method of sterilisation;
  - Name of the operator

### Examples of forms

### Substrate Sterilisation Record

Date	Location of sterilisation / Block Id	Chemical			Application method	Machinery used	Weather conditions (wind speed & direction)	Applied by
		Name	Active	Rate				

## FV.3 Irrigation / Fertigation

### What the GLOBALGAP protocol requires

Nº	CONTROL POINT	COMPLIANCE CRITERIA	LEVEL
<b>FV.3.1 Quality of Irrigation Water</b>			
FV.3.1.1	According to the risk analysis (CB.6.3.2), does the analysis consider the microbial contaminants?	According to the risk analysis (if there is a risk of microbial contaminants), there is a documented record of the relevant microbial contaminants through a laboratory analysis.	Minor
FV.3.1.2	If the risk analysis so requires, have adverse results been acted upon?	Records are available of corrective actions or decisions taken.	Minor

### What this means

Water testing should include faecal organisms that could contaminate produce (eg E. coli). *Guidelines for on-farm food safety for fresh produce* suggest product testing may be required if faecal coliforms in irrigation water exceed 1000 cfu/100ml (cfu = colony forming units).

Results for microbial contaminants should be confirmed against national recommendations by the testing laboratory. There are national standards set by the National Health and Medical Research Council for potable water (which labs tend to quote), and national guidelines for irrigation water. Refer to Australian and New Zealand Guidelines for Fresh and Marine Water Quality.

If, indicated by an adverse test result, the risk of contaminating product is significant, either a safe alternative water source must be used, or the water must be treated to minimise the risk of contamination. Where water is treated, the treatment method must be monitored and the results recorded. The source of contamination should also be investigated.

### What you have to do

- If the risk analysis (CB.6.3.2) indicates the risk is high, then water testing will need to be undertaken at a frequency related to the likelihood of the risk. For instance, microbial contamination may be highest during times of low water flow or when stock have had access to water.
- Contact one of the laboratories listed on the NATA website. This will ensure the lab is NATA accredited to do microbiological water tests. Request the water be tested for thermotolerant faecal coliforms. The laboratory will provide you with equipment and instructions on how to collect the water sample.
- When the test results come back, check that the level of thermotolerant faecal coliforms is less than 1000 / 100ml. If irrigation water has more thermotolerant coliforms than 1000 / 100ml, you will need to investigate other water sources, particularly for ready to eat product that may not be further washed or treated (lettuce, apples, broccoli).
- If the results of water testing indicates that water is not suitable for irrigation, you need to record action taken, which may include:
  - Advising your customer so they can segregate the product and deal with it as appropriate (eg test product for contaminants, wash and rinse more thoroughly)
  - Seek an alternate, safe source of water
  - Identify the source of contamination and take steps to control it
  - Consider water treatment (if you do this, you will need to keep records of the treatment and results of treatment)

## FV.4 Harvesting

### What the GLOBALGAP protocol requires

Nº	CONTROL POINT	COMPLIANCE CRITERIA	LEVEL
<b>FV.4.1 General</b>			
FV.4.1.1	Has a hygiene risk analysis been performed for the harvest and pre-farm gate transport process?	There is a documented and up to date (reviewed annually) risk analysis covering physical, chemical and microbial contaminants and human transmissible diseases, customised to the products. It must also include FV.4.1.2 to FV.4.1.9. The risk analysis shall be tailored to the scale of the farm, the crop and the technical level of the business. No N/A.	Major
FV.4.1.2	Are documented hygiene procedures for the harvesting process implemented?	The farm manager or other nominated person is responsible for implementation of the hygiene procedures. No N/A.	Major
FV.4.1.3	Have workers received basic instructions in hygiene before handling produce?	There must be some evidence that the workers received training regarding personal cleanliness and clothing e.g. hand washing, wearing of jewellery, fingernail length or cleaning, etc.; personal behaviour, e.g. no smoking, spitting, etc (reference AF.3.1.1).	Major
FV.4.1.4	Are hygiene instructions and procedures for handling produce to avoid contamination of the product implemented?	There is evidence that the workers are complying with the hygiene instructions and procedures. Packers must be trained, using written (in appropriate languages) and / or pictorial instructions, to prevent physical (such as snails, stones, insects, knives, fruit residues, watches, mobile phones etc.), microbiological and chemical contamination of the product during packing.	Major
FV.4.1.5	Are the containers and tools used for harvesting cleaned, maintained and protected from contamination?	Reusable harvesting containers, harvesting tools (i.e., scissors, knives, pruning shears, etc) and harvesting equipment (machinery) are cleaned and maintained, and a cleaning and disinfection schedule is in place (at least once a year) to prevent produce contamination.	Major
FV.4.1.6	Are vehicles used for transport of harvested produce cleaned and maintained?	Farm vehicles used for transport of harvested produce that are also used for any purpose other than transport of harvested produce, are cleaned and maintained, and a cleaning schedule to prevent produce contamination is in place (i.e. soil, dirt, organic fertilizer, spills, etc.).	Major
FV.4.1.7	Do harvest workers that come into direct contact with the crops have access to clean hand washing equipment?	Fixed or mobile hand washing equipment is accessible to harvest workers. No N/A.	Major
FV.4.1.8	Do harvest workers have access to clean toilets in the vicinity of their work?	Fixed or mobile toilet facilities (including pit latrines) constructed of materials that are easy to clean and with catch basins designed to prevent contamination in the field are accessible to harvest workers within 500m and they are in a good state of hygiene. Where an employee is working independently, the 500m distance can be modified to allow the presence of toilets at an increased distance, providing there is reasonable and adequate transport available to the worker. No N/A.	Minor

Nº	CONTROL POINT	COMPLIANCE CRITERIA	LEVEL
<b>FV.4.1 General (cont'd)</b>			
FV.4.1.9	Are produce containers used exclusively for produce?	Produce containers are only used to contain harvested product (i.e. no agricultural chemicals, lubricants, oil, cleaning chemicals, plant or other debris, lunch bags, tools etc.). If multi-purpose trailers, carts etc are used as produce containers, they must be cleaned prior to use.	Major

### What this means

An industry-endorsed Hygiene Risk Assessment has been undertaken for apples for harvest and pre-farm gate activities. This risk assessment is detailed below.

Growers who are already part of an industry HACCP based system (eg SQF 2000, SQF 1000, Freshcare) can utilise the Hazard Analysis/Risk Assessment developed under their food safety code.

The Hygiene risk assessment must include:

- Identification of the food safety hazards in the harvesting process;
- Assessment of the risk posed by each of the identified hazards;
- Identification of the operational control measures that will prevent or eliminate the food safety hazards

Personal hygiene standards must be followed to minimise the risk of microbial, chemical and physical contamination of produce from staff (including family members) that come into direct or indirect contact with produce.

This must also apply to packing operations (produce handling operations - refer to FV.5).

Unless the risk assessment demonstrates no or minimal risk for the crop being harvested the grower must ensure that procedures are documented and implemented for the following:

- All packaging material is stored in an area and in a manner that will prevent contamination by pests, dust, chemicals etc;
- Harvest workers have received hygiene instructions in line with the activities they are performing;
- Field bins and other harvest containers that are re-used are cleaned and sanitised regularly, and a cleaning schedule, cleaning instructions, and a cleaning record is available;
- Harvesting equipment is cleaned and sanitised regularly, and a cleaning schedule, cleaning instructions, and a cleaning record is available;
- All harvested product is removed from the field overnight, and is covered during transport and storage;
- All produce, whether harvested or farm-packed, must be stored in clean, well-lit and well-ventilated storage areas, Product that requires temperature storage must be stored in clean, well-ventilated storage with adequate temperature and/or humidity control. If produce is stored under controlled temperature / humidity conditions records must be kept of temperature and humidity levels.

Note: GLOBALGAP uses the word 'disinfection' of tools and equipment. In Australia, the terms 'sanitise' or 'sanitisation' are more commonly used.



## Addressing risk and barriers to entry

What have we been up to?

Prepared by  
Jane Lovell  
Tasmanian Quality Assured Inc

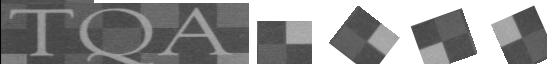

## Overview of activities

- Attended EurepGAP workshop and conference in Prague
- Assisted with implementation of EurepGAP
- Conducted Field to Fork audits on behalf of Empire World Trade
- Assisted with implementation of BRC (British Retail Consortium Global Standard – Food)

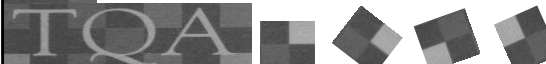

## Has anything changed?

- No
- The systems continue to morph and adapt
- Retailers continue to want a bit more

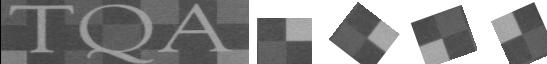
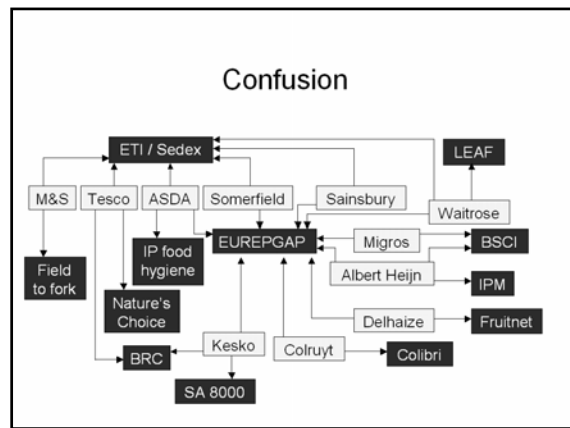
## On the horizon

- ETI (Ethical Trade Initiative) Audits
- Other environmental programs such as LEAF (Linking Environment And Farming)
- Carbon footprinting
- Additional pesticide requirements



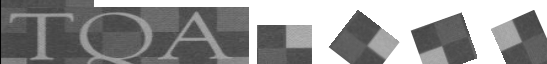

### So what do your major customers want?

- Growers
  - EurepGAP is still the base standard
  - Field to Fork for M&S
  - Natures Choice for Tesco
  - Sedex
- Packhouses
  - BRC- particularly if direct supplier and using branded packaging
  - Field to Fork for M&S
  - Natures Choice for Tesco
  - Sedex



### What have we done about it?

- Put the Australian perspective at EurepGAP workshop where proposed alterations to standard were discussed
- Won some, lost some
- Developed new Interpretive manual for EurepGAP
- Sought better understanding of Field to Fork and put the Australian perspective

### What is ahead?

- Distribution of new Interpretive Manuals
- Official training in Field to Fork
- Field to Fork audits
- Assistance with system implementation

### Changes to EurepGAP

- New version comes into force from 1 April 2008 (funny date!)
- Now called GlobalGAP
- Gone from one standard to three modules
  - All Farms Base
  - Crops Base
  - Fruit and vegetables

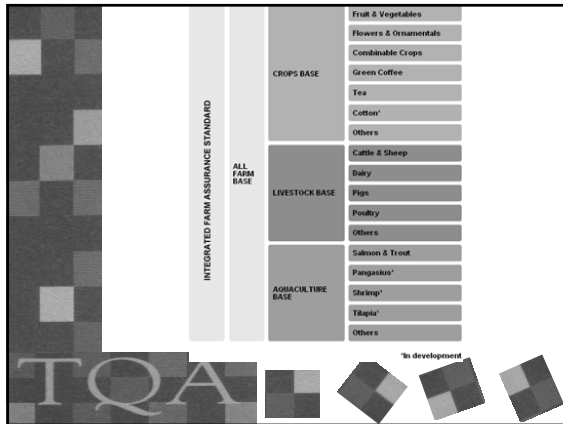

## Changes to EurepGAP

- Number of elements
  - Majors from 49 to 74 (UP 25)
  - Minors from 99 to 125 (UP 26)
  - Recommendeds from 66 to 37 (DOWN 29)
- Deleted Control Points
  - 1 Minor
  - 6 Recommended
- Level changes
  - 20 elements have gone from Recommended to Minor
  - 3 elements have gone from Recommended to Major
  - 7 elements have gone from Minor to Major

## Changes to EurepGAP

- New headings
  - Traceability
  - Integrated Pest Management
- New sub-headings
  - Subcontractors
  - Energy Efficiency
  - Sowing / Planting
  - Nutrient requirements
  - Final Produce Packing at Point of Harvest
  - Personal Hygiene
  - Quality Control
  - Rodent and Bird Control

**Thank you**

**Things to know about Prague;**

Some supermarkets stock more alcohol than food

Beer is ½ the price of milk

A litre of vodka is the same price as a litre of milk

Sauna's are uni sex and people don't wear clothes in there!

## GLOBALGAP – what could bite you?

- Safety advice available/accessible for substances hazardous to health (MSD sheets) (Minor)
- Records of all workers, including seasonal workers and subcontractors, working on farm (Minor)
  - Full names
  - Date of entry
  - Period of employment
  - Regular working time and overtime regulations

**GLOBALGAP – what could bite you?**

- Subcontractors must carry out an assessment of compliance against GlobalGAP (can include audit to verify) (Minor)
- Clean food storage areas, designated dining areas, hand washing facilities and drinking water (Minor)

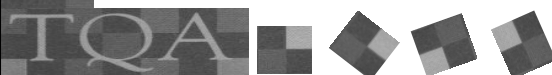

**GLOBALGAP – what could bite you?**

- Management of wildlife and conservation plan now a MINOR (was Rec)
- Show monitoring of energy efficiency on farm and energy use records exist (Rec)

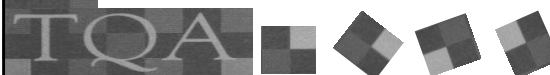

**GLOBALGAP – what could bite you?**

- Recall procedure (Major)
- Annually test recall procedure (Major)
- Inform direct clients of GM status of product and evidence of communication (Major)
- Purchased inorganic fertilisers need documentary evidence of chemical content (Rec)

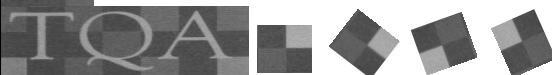

**GLOBALGAP – what could bite you?**

- Show at least one Preventative IPM activity (Minor)
- Show at least one Observation and Monitoring IPM activity (Minor)
- Show at least one Intervention IPM activity (Minor)
- Keep invoices for ag chemicals (Minor)

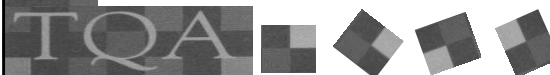

**GLOBALGAP – what could bite you?**

- Procedures for dealing with re-entry times (Major).
- Documented compliance with re-entry times (Minor)
- Must be evidence of training workers re hygiene (including pickers) (Major)
- Must be procedures for handling produce to avoid contamination (Major)

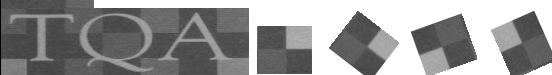

**GLOBALGAP – what could bite you?**

- Must be evidence of compliance with hygiene requirements (Major)
- Whole new section on packing in the field (Majors and Minors)
- Packing
  - All workers must wear outer garments fit for purpose (Rec)
  - Signs – hygiene, hand washing, visitors (Major)
  - Changing rooms (Rec)
  - Secure storage facilities for workers things (Rec)

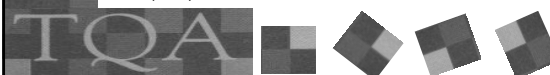

**GLOBALGAP – what could bite you?**

- Forklifts etc clean (Rec)
- Gas or electric forklifts etc for internal transport (Rec)
- Packing materials (including bins) stored in a clean hygienic condition and area (Minors)
- Documented final inspection process (Minor)

TQA

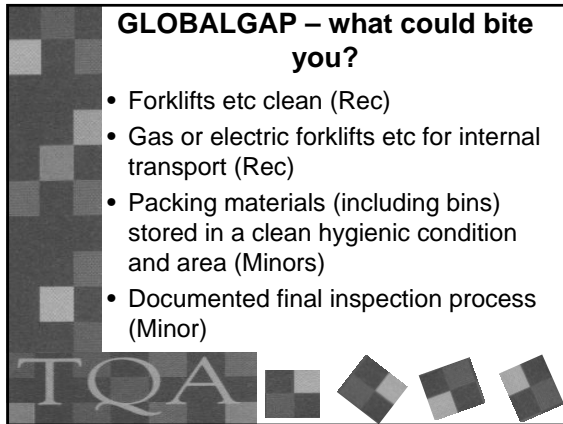

**GLOBALGAP – what could bite you?**

- Stock rotation managed (Rec)
- Verify and measure temp control (Minor)
- Routinely check weighing and temp control equipment (Minor)

TQA

