

**VG99075**

**Protected Cropping Technology  
Investigation Tour to Israel**

**C Feutrill and R Kennedy**

**Virginia Horticulture Centre and SA  
Farmers Federation**



*Know-how for Horticulture™*

**VG99075**

This report is published by the Horticulture Australia Ltd to pass on information concerning horticultural research and development undertaken for the vegetable industry.

The research contained in this report was funded by Horticulture Australia Ltd with the financial support of the vegetable industry and the Virginia Horticulture Centre.

All expressions of opinion are not to be regarded as expressing the opinion of Horticulture Australia Ltd or any authority of the Australian Government.

The Corporation and the Australian Government accept no responsibility for any of the opinions or the accuracy of the information contained in this report and readers should rely upon their own enquiries in making decisions concerning their own interests.

Cover price: \$22.00 (GST Inclusive)  
ISBN 0 7341 0188 0

Published and distributed by:  
Horticultural Australia Ltd  
Level 1  
50 Carrington Street  
Sydney NSW 2000  
Telephone: (02) 8295 2300  
Fax: (02) 8295 2399  
E-Mail: [horticulture@horticulture.com.au](mailto:horticulture@horticulture.com.au)

© Copyright 2001

---

**Horticulture Australia Limited**

**VG99075 Protected Cropping Technology Investigation Tour To Israel.  
Final Report**



***"In Israel, it's all about water - who will control it, and will there be enough. Will nature be generous or cruel? Each cloud is looked upon with hopefulness. Each drop of rain is savoured like a fine wine."***

Time Magazine

1999



**Craig Feutrill, SA Vegetable Industry Development Officer, SAFF  
Rob Kennedy, Production Industry Development Officer, VHC**



**Protected Cropping Technology  
Investigation Tour - Israel 2005**

**Sunday May 14<sup>th</sup> to Monday May 23<sup>rd</sup>**

<b>Contents:</b>	<b>Page No</b>
<b><u>Executive Summary, Including Implications for Australia</u></b>	<b>4</b>
<b><u>Aims and Objectives of the Tour</u></b>	<b>6</b>
<b><u>Comparison of Israel and Aust. Greenhouse &amp; Nursery Industries</u></b>	<b>8</b>
<b><u>Tour Itinerary</u></b>	<b>9</b>
<b><u>Day 1 Hishtil Seed Nursery</u></b>	<b>10</b>
<b><u>Day 2 Jordan River Herbs, Field Corn, Kibbutz Bet Hashitta</u></b>	<b>15</b>
<b><u>Day 3 AZROM, Eldar Shany, Moshav Shequev, Moshav Shar</u></b>	<b>20</b>
<b><u>Day 4 Hbsor Research Station, Mivtahim Tomatoes,</u></b>	<b>27</b>
<b><u>Day 5 Kibbutz Yoteva Research Station, Moshav Ein Tamar</u></b>	<b>34</b>
<b><u>Day 7 Kibbutz Netafim &amp; Seminar, Potatoes at Magal,</u></b>	<b>42</b>
<b><u>Contacts</u></b>	<b>55</b>
<b><u>Acknowledgments</u></b>	<b>56</b>
<b><u>Tour Participants</u></b>	<b>57</b>

# **Executive Summary – Including Implications for the Greenhouse Industry in Australia**

From Sunday May 14<sup>th</sup> to Monday May 23<sup>rd</sup> 2000, twenty one growers and two Industry Development Officers participated in a tour of the Greenhouse Industry of Israel. The tour was led by Robert Kennedy, an Industry Development Officer for the Northern Adelaide Plains (NAP) region in SA, funded by the Virginia Irrigation Association and the Horticultural Research and Development Corporation (HRDC) and assisted by Craig Feutrill, the SA Vegetable Industry Development Officer, fully funded by HRDC.

The tour was initiated after requests by growers on the NAP to look at greenhouse technology, pest and disease management (particularly with a view to Western Flower Thrips (WFT) control) and production overseas as it was recognized that the local (and generally Australian) industry was lacking input as to how to become competitive in the current economic climate.

The grower delegates to the tour were from South Australia (9), Queensland (11) and New South Wales (1), and represented most aspects of the Greenhouse and Nursery Industries. Crops grown by the delegates included: capsicums, zucchini, tomatoes, watermelon, flowers and cucumbers. Four Vietnamese growers were included as part of the SA delegation – as they make up the majority of the Greenhouse production in the state.

The tour visited properties the length and breadth of Israel, in the capable hands of AZROM and NETAFIM personnel from Israel and Australia. Regions covered during the tour included: Tel Aviv region, Jordan River, Beit Shean Valley, Hayagev, Nativ Hasara, Ashkelon, Negev Desert, Eilat, Hbsor, Ein Yaav, Ein Tamar, Jordan Valley, Magal and Netanya.

The delegates visited nurseries, condiment and herb farms, AZROM greenhouse manufacturing facilities, 2 research stations, one in the Negev desert, Netafim manufacturing and irrigation R&D facilities, Shany Eldar Gal irrigation controller company and vegetable grower properties who were using the new technology successfully. Where broadacre production was associated with a research facility, this was also investigated.

Generally the growers were astounded at the technological developments in the Greenhouse Industry of Israel, not just the varieties grown, but production technology, greenhouse structures, pest and disease control, irrigation technology – particularly using less than ideal water and marketing aspect of Israeli production. This reflects the fact that the Israeli growers will not plant crops unless they are pre-sold or have a guaranteed market. Often when the Israeli growers were asked by tour delegates if the crops being produced were pre-sold, the answer came back “of course”! Other valuable information gathered regarded the apparent control of WFT that the greenhouse growers had – the use of sticky bands around the base of the greenhouses, total weed control and insect proof netting illustrated that the crops can be grown in the presence of the pest.

Greenhouse structures were looked at closely – and the fact that 4 metre gutter heights are standard and Israeli growers produce crops in a cubic volume – not on a per square metre floor space – in easily controlled atmospheres, was not lost on the Australian delegates.

The implications of bringing the technology and production methodology into Australia is vast – and the majority of the growers on returning to Australia have implemented at least some of the technology. Insect netting has been installed in a few Australian greenhouses and a few of the

growers are looking at raising the roof height and using ventilation systems to control the atmosphere inside the greenhouses to lessen disease and produce more consistent crops. Since returning from the tour, a number of extension activities have occurred .

These include:

- A grower information night at the Virginia Horticulture Centre, which was attended by approximately 50 growers who did not attend the tour. The highlight of this tour was that the grower delegates each got up and spoke of their impressions of the Israeli Greenhouse industry, and how they were going to change their practices as a result of the tour.
- Informal morning meetings at P&P Rural Supplies with the Vietnamese community to discuss the tour – and ensure the message was getting to the Vietnamese growers.
- Publication of the tour findings in 4 successive issues of Good Fruit and Vegetables and the SA Grower 'Veglink' articles.
- The VegLink articles have been translated into Vietnamese both through the VegLink publication and the Vietnamese Farmers Association Newsletter.

The outcomes of this project also tie in with other projects currently underway through the Virginia Horticulture Centre.

AZROM Metal Industries have kindly donated a 1000 metre squared greenhouse to the region, Netafim have donated the irrigation equipment for the project. A project has been submitted to HRDC to support the project and other funding has been sought.

A Greenhouse Project Manager, Alec Townsend has been appointed and is currently reviewing the project aims.

Essentially the project will be a trial and demonstration site and we are hoping to attract further Greenhouse Manufacturers to put up structures for the local (and interstate) growers to view.

This is the ultimate extension of the tour project because we can address the age-old grower statement "don't tell me – show me". It is bringing a small part of Israel to Australia so that all growers can see the technology first-hand.

Craig Feutrill  
Robert Kennedy  
October 2000

# **Aims/Objectives of the tour.**

This project was initiated at the request of local greenhouse and hydroponic growers, to investigate, evaluate with the view to import and adopt protected cropping technology from Israel into Australia.

The issues and challenges facing the protected cropping industry in South Australia are numerous, from overabundance of some lines, lack of skilled labour, quality issues, to the devastation caused during the 1999/2000 season by Western Flower Thrips. Continued competitiveness of these industries depend on the ability of the growers to grow produce at nationally and internationally competitive prices. This can only be achieved by being aware of, and using World's best practice and technology to suit our growing conditions.

The greenhouse and hydroponic industry members are to tour Israel, supported by a major Greenhouse manufacturer, AZROM, and an international irrigation manufacturer, NETAFIM. Once in Israel, these two companies will be hosting the Tour group to the manufacturing facilities, trial sites (irrigation and protected cropping), commercial operations, seed companies and research establishments.

Whilst in Israel, Tour participants will have the opportunity to attend part of the World Congress on soilless culture - "Agriculture in the coming millennium" which is being held from May 14th to the 20th. A maximum of 20 participants from the Australian protected cropping industries will be eligible for matching funds.

The primary purposes of the Tour are:

1. To observe and discuss technology first hand that might be appropriate for adoption by Australian protected cropping industry to improve their businesses..
2. To improve the understanding of overseas R&D and its relevance, encouraging growers to be more active in prioritising research in Australia.
3. To establish and promote linkages between Australian growers and overseas industry members and researchers

In South Australia, the major glasshouse crops are tomatoes, capsicums and cucumbers and have a combined value of \$107 million (Venton Cook, PIRSA, 2000, pers comm). The Australian total value for tomatoes, cucumbers, capsicums and zucchini is approximately \$452.4 million (ABARE, 1997 figures), of which only \$11.1 million is exported.

Over the past decade there has been a dramatic increase in the number of glass and shade-house structures. From the survey conducted by PIRSA in 1999, to develop a land-use map for the Northern Adelaide Plains (NAP), there is 463 hectares of glasshouse/polyhouse and 134 hectares of shade-houses constructed in the region.

This industry sector consists mainly of small family businesses, which provide most if not all of the labour. English as a second language is a major issue as the operators are predominantly Vietnamese and Cambodian - and these growers may not have originated from a horticultural background.

In the main, the properties are 1-2 Ha with 20 to 50 glasshouses. Entry into the glasshouse industry requires less capital than field crops; consequently most new entrants to horticulture tend to gravitate to this form of production. Leasing of glasshouses is common, and this form of agreement assists under-capitalised operators to enter the industry. The result being limited infrastructure improvement and minimal uptake of new technology.

The production of main protected crops for the 1999/2000 year on the NAP is Cucumbers (50%), Capsicums (25%), and Tomatoes (25%).

Continental and Lebanese are two main types of cucumbers grown and are sold by number, not weight. Production is approximately 2.5 plants per square metre with each plant producing two crops per year. Continental cucumbers are sold in lots of 15 per bag and Lebanese 28-32 per box. Over the season the price fluctuates between \$2-\$15.

Capsicums plants produce for a maximum of 4 months at 5 kg per square metre and the return to the farmer ranges from \$1-\$5 per kg.

Tomatoes are cropped at 2.5 plants per square metre with a 4kg production per plant, which equates to 10kg per square metre. The price fluctuates between 60 cents-\$4 per kg, with an average price of approximately 80 cent-\$1 per kg returned to the grower.

This sector of the vegetable industry is production driven and has an extremely fragmented supply chain, furthermore there has been little change in the crop varieties of the technologies used over the past decade. The 'better' growers supply large pack-houses that sort, grade and on-sell to large retail outlets. Growers that have not established relationships with the supply chain tend to deal in spot prices either at the local Pooraka markets or with wholesale agents. Marketing on spot pricing generally has the effect of a lower return to the farmer who in turn produces more product in the belief that they can get ahead of the game.

Of all the industry sectors on the NAP, the greenhouse industry is the most challenging. There needs to be an infusion of the latest technology, training in best farm practices (including Western Flower Thrips management strategy) and in small business management. The new technology needs to be aimed at meeting market need for quality, consistency and higher valued products and value addibg where possible. Diversification into new and different crops and positioning the sector to react to changes iin the market place would make the growers more economically sustainable.

To improve the competitiveness of the SA and Australian Industry we must import and adopt the technology and practices of overseas industries/competitors.

Whilst in Israel, the tour delegates have the opportunity to investigate Western Flower Thrips management strategies, both for protected cropping and field grown crops at the Habsor Research Station. New technologies for water recycling & filtration, drip irrigation, protected cropping structures and control systems for greenhouses.. New vegetable varieties will be investigated and a seminar on growth models for vegetables will be attended.

The tour delegates (hydroponic) will also have the opportunity to attend part of the World Congress on soilless culture "Agriculture in the coming millennium"

Little has previously been undertaken on behalf of the Australian Protected Cropping industry with regard to overseas information missions. Larger companies, particularly hydroponic growers have visited Israel and Spain but have tended to keep the information for personal gain. This tour will produce a report, which being written primarily by growers during the tour, will be available to the protected crop industry in Australia. The tour delegates will be given key areas to research and understand and at a debrief session each evening will be asked to put forward their impressions and understanding. This is the key to the success of the project. As we have seen with the Western Flower Thrips grower based working group in South Australia, the concept of growers helping growers has been very well received.

[Contents Page](#)

[Main CD Homepage](#)



# Comparison of Israel and Australian Greenhouse and Nursery Industries

## Israel (Overview)

- Less than ½ the size of Tasmania - 28,000sqkm
- Human history extends back over 5000 years
- As a nation barely 50 years old
- Geographical terrain of incredible contrast - snow capped mountains to sun-baked desert

Israel has very little rain in Spring (time of visit), and very high evaporation.

There are two types of farming enterprise:

1. Moshav (from Hebrew: 'to settle') which is an independent group of growers in a settlement with separate houses and production system but working toward the common good.
2. Kibbutz – a community owned enterprise – a cooperative.

Most of the water used for Israeli horticulture is from reclaimed sewage or from the freshwater 'Sea of Gallilee'.

Land is measured in 'dunams' and 1000 metres squared is a dunam.

## Comparison:

Israel's greenhouse Industry is well serviced by Government Agencies, consultants and greenhouse manufacturers, both for research and development of crops and structures. Generally the industry is modern and innovative with new structures and production techniques. Exports to Europe and other destinations ranges from 60% to 90% with most of the crop pre-sold even before it is planted.

Irrigation used can be fresh water from the Sea of Galilee, but more often that not is secondary or tertiary treated reclaimed water – water storage is becoming an important aspect of farming in Israel as production increases beyond the capabilities of both fresh and reclaimed water resources.

Australia generally has a greenhouse industry based on production and structures that have their designs rooted in the 1950s. There are some modern greenhouses, but not many. Production from the greenhouses is primarily for domestic consumption, with little export occurring. This leads to boom or bust scenarios as growers can rapidly change crops to address what they perceive as market needs.

Water used is generally good quality, with little or no reclaimed water used. With the potential salinity problems of the Murray in future years in some states, water quality and use of less quality water will become a major issue.

### **Grower Comments:**

*A must for Australia is the implementation of a plan to treat and reuse sewage water – pumped from the cities to the irrigation areas. In Israel all water was pumped via pipes, not channels thus reducing evaporation. We need to be more conscious of efficient water use. The practice of retrieving and reusing heavier trickle tape for broadacre agriculture should be promoted in Australia as just about all broadacre cropping seen on the tour was under drip irrigation.*

[Contents Page](#)

[Main CD Homepage](#)

# Itinerary

## Itinerary for Visit to Israel 14<sup>th</sup> – 23<sup>rd</sup> of May 2000, to Inspect Greenhouse and Irrigation Technology

### Monday 15<sup>th</sup> of May

- Nehalim, Hishtil Nurseries
- *Overnight in Ramat-Gan, Optima Hotel*

### Tuesday 16<sup>th</sup> of May

- The Jordan River, Condiment/Herb Farm
- Beit Shean Valley
- Hayagev, Greenhouses
- *Overnight at Ashquelon, Holiday Inn*

### Wednesday 17<sup>th</sup> of May

- Azrom, greenhouse manufacturing facility
- Nativ Haasara, Greenhouses
- Shany Eldar Gal
- *Overnight at Ashquelon, Holiday Inn*

### Thursday 18<sup>th</sup> of May

- The Hbsor Research Station
- Ein Absor
- Kibbutz Mivtahim, Tomatoes
- *Overnight at Eilat, Nova Hotel*

### Friday 19<sup>th</sup> of May

- Kibbutz Yotveta, Research Station
- Ein Yaav
- Ein Tamar
- *Overnight at Dead Sea, Golden Tulip Hotel*

### Saturday 20<sup>th</sup> of May

- Tour of Jerusalem
- *Overnight at Netanya, Seasons Hotel*

### Sunday 21<sup>st</sup> of May

- Kibbutz Netafim, Manufacturing and Research facility, Magal
  - o Seminar, 'Growing Vegetables in Greenhouses'
  - o Greenhouse Park and the factory

### Depart

[Contents Page](#)

[Main CD Homepage](#)

## Day 1. Hishtil Seedling nursery, Nehalim. Led by Hananel.

Approximately 15km east of Tel Aviv is the Hishtil Seedling Nursery. Hananel, the Director of Operation for Hishtil led the tour.



Hishtil grows two kinds of seedlings, vegetable and ornamental. Although we were shown the vegetable seedling nurseries by far the largest of the Nehalim operations was directed at ornamental seedlings for the landscaping industry.

There are 100 full time employees and 100 part time in the 7 nurseries Hishtil runs.

Hishtil is the largest seedling nursery in Israel and has 7 operations such as the one investigated. Most of the seedlings/ornamentals are sold onto the domestic market, although a large percentage is exported to Europe.

The tree main stages of seedling production are:

1. Filling trays with media
2. Planting seedling
3. Germination/growth



Media holder – 120 to 150 cells for vegetables  
390 cells for flowers (see photo)



Hishtil have just imported a machine that automatically transplants from one sized cell block to a larger block (Fleer – Europe). Up until 6 months ago all transplanting was manual (see more later)

Hishtil produces 500,000 to 600,000 seedlings 3 times a year. The media used is a very fine peat moss (imported from Finland) plus a little bit of vermiculite. Hananel was not forthcoming on the fertilizer mix save to say that it varied both for flowers and vegetables as well as at the different transplanting stages of the seedling – and furthermore to assist in the speed/hardiness of the seedling development.

The seedlings, once planted are moved into the hothouse which has a humidity of 95% or greater. The seedlings remain in the hot house for 1 to 5 days and are then moved to the greenhouses.

Greenhouse: Main concentration in Nehalim greenhouses is landscape ornamentals (Vinca).



The seedlings are for a typical summer landscaping purchase in Israel. The seedlings are repacked into big cells (50 per tray).

Vinca is produced in the following variations: short, tall, medium and creeping and in up to 16 colours. Geraniums can be produced in 90 colours. If demand for the seedlings is high, they close the roof to speed up growth.

The greenhouse we looked at was an Azrom greenhouse, about 20 years old (typical twinskin model). The twinskin has been replaced with a single skin, with 'lifters' to push the plastic up off the frame.

Competition is very high in the greenhouse ornamental nursery business in Israel, so Hishtil must make sure all decisions will make money, i.e. they will work out (based on historical information) how much heating of the greenhouses will cost for the year at the start of the season.

The greenhouses have overhead lighting, to assist in the production of 'long-day' flowers. The operators play with the location of the plant, hardening off outside the greenhouse if the plant variety becomes 'too soft'. They also will change day length. Typically they start with fast growth and then move the plant according to orders i.e. if the buyer/consumer wants short day flowers they will speed them up with warmth/humidity and no overhead lights. Harder plants will be placed outside prior to sale.

Flowers sell for 1.5 Shekels (about 70 to 80 cents Australian) wholesale.

Hananel made a comment "we run a profitable farm, not a pretty one" – this applied to all enterprises seen.

The next greenhouse viewed had insect proof netting (not fine enough to keep out WFT). The netting was in place to satisfy European Common Community regulations as there are insects in Israel which Europe does not have.

Hishtil produces perennial plants (usually hardier plants) in a greenhouse with 30% shade mesh (insect proof), but colour of the mesh allows a little more light to penetrate so typically shade offered is between 25% to 27%. To heat the greenhouse there is plastic hot air fluming under the beds.

Azrom have developed an external thermal screen, to reduce heat damage to plants during the hot season. However, the external screen, although good for heat reduction is more sensitive to wind damage.

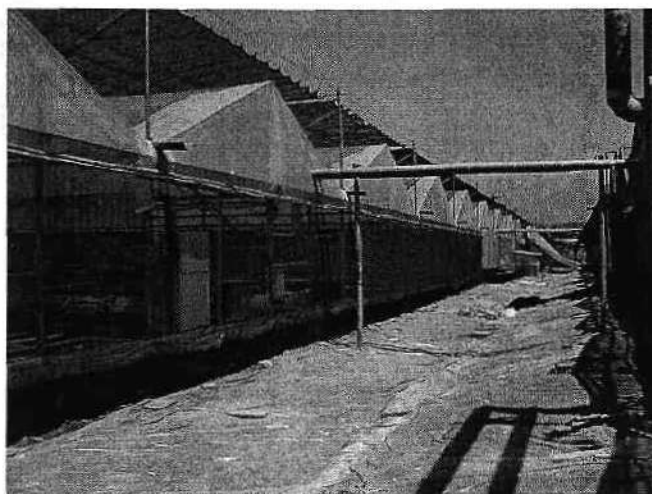

For reducing heat and saving heating energy, the thermal screen can be placed inside the greenhouse – usually these are placed in greenhouses growing the more sensitive, seasonal plants. There are also drop down screens between the bays so different sections of the greenhouse can be run with different temperature/humidity requirements to suit the seedlings being grown. The side curtains for the greenhouse were upside down and automatically controlled to ensure regular temperature and humidity.

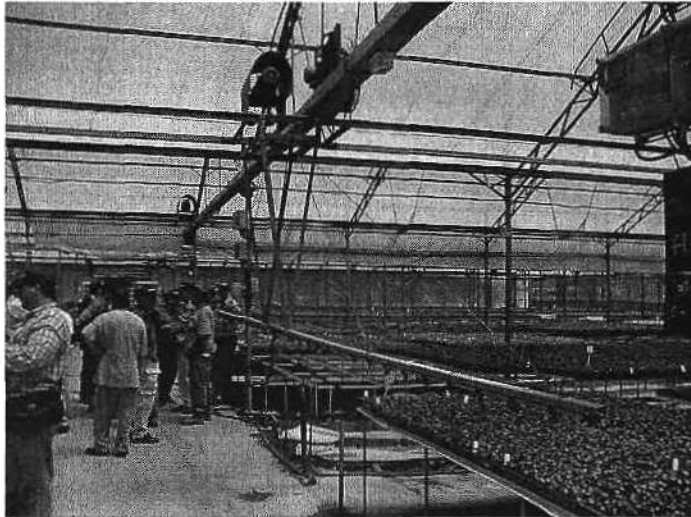

Irrigation is via a moving, overhead boom, and irrigation is set according to the needs of the crop via number and size of the jets.

A chemical spray boom can also be attached to the same system – with a different supply hose for insect or disease control.

Fertigation occurs through the same irrigation system, but again through a different supply system.

Temperatures outside the greenhouse will be 6 to 7 degrees Celsius. The greenhouse temperature will not go below 16 degrees Celsius (lowest development temperature for the seedlings).

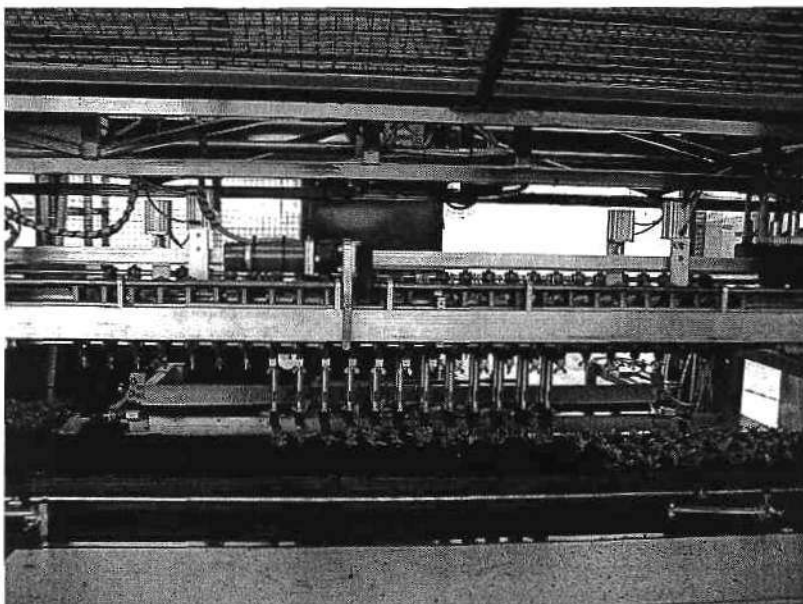

Hishtil's auto transplant machine is for moving seedlings from small to big cell trays.

[Contents Page](#)

[Main CD Homepage](#)

The slowest setting for transplanting does 400 trays and hour (to the biggest celled tray). When compared to manual transplanting where the workers would achieve an average of 200 trays per day, the benefits can clearly be seen.

If transplanting to smaller cells can go up to 800 trays an hour, with medium cells being 600 trays an hour.

They will change the media in response to what they believe the market will be, i.e. slower or longer growth.



**Marketing:** Hishtil has a central marketing body who also ships seedling out to buyers. The plants are grown according to historical data on previous orders and orders received from sales representatives who actively sell the seedlings. Most buyers are the retail nurseries.

Boxes for shipping cost \$1 AUD (in Israel) and are produced and imported from Turkey. A similar box would cost \$1.45 in Australia by AMCOR or APM.

**The Export Marketing Centre:** Every morning, keep some from everything grown/packed from the day before. In the afternoon, they have to take it back into the greenhouses (there is always extra). Plants should remain only 24 hours, maximum in the Marketing centre/greenhouse when it is ready for sale – this is to ensure the product is best presented and has the maximum shelf-life in the retailers.

The Israeli nursery industry uses two types of greenhouse heating systems.

1. Hot air generators which are cheap to buy but expensive to use or,
2. Hot water systems which are expensive to purchase but cheap to use.

The hot water systems are fuelled by coal, oil, gas etc and run the water through aluminium or polybutene pipes, and are run for about 3 months of the year.

#### **Grower Comments:**

*The peat moss used in this nursery, on the inspection day, was from Germany. The mixer used teases teases the peat moss apart before it is blended into the vermiculite – which looks like at least 50% mix. Growers in Australia use approximately 20% peat moss, with bulk being made up of perlite and vermiculite.*

*If the mixing was done by hand, then the Finnish peat would save time. German peat is 'lumpy'.*

*The forestry nurseries in Australia have automatic seed planting. I'm sure there are other units similar to the one seen at Hishtil in Australia.*

*With all of the sunlight in Israel, you would think solar hot water heating would be used instead of coal, oil and gas.*

## Day 2: Herb Farm – Manager Yehuda Renis (Translated by P. Anderson)



The herb farm grows 17 different types of herbs and pack every day. Cleanliness of the packing area is paramount as they supply to the large supermarket chains in England (Sainsburys, Tesco) who can send inspectors to spot check the enterprise.

Basil is the main crop with 30 to 40% of the production. Basil has different temperature requirements to the other herbs produced so must be separately cooled.

All herbs are harvested, packed then chilled. All product is forward sold.



Hygiene and correct picking of basil is very important.

Herbs are grown hydroponically in scoria media. “The greenhouse may be primitive, but the basil is seen on the best shelves in Europe”

For insect control, they must cut the basil back to the base stem and then spray – that way there are no chemical residues left on the growing leaves. Pests that require control

include, caterpillar, leafminer and aphids. As a requirement of QA, leaf samples are taken weekly for residue analysis. The Herb farm uses biological control to minimize pests and chemical control.

They harvest whole rows at a time.

Irrigate 3 times a day in spring/summer and in winter 1 time a day although this can drop to once every 2 days. The water run off from irrigation is monitored for volume, content and subsequent irrigation/fertilizer needs based on the outcome. The type of media used is important for this.





Bore water is used for irrigation. A one metre raised bed is used for monitoring purposes and all run-off from this is measured for pH, quality, EC, nutrients, volume etc – this is measured once a day and the subsequent irrigation based on the outcome.

Problems with Basil occur because they are cutting it all the time, and particularly during winter the wounds can get botrytis in them due to the high humidity in the greenhouse. To combat this they have extraction fans set in the walls to reduce the humidity during the winter months.

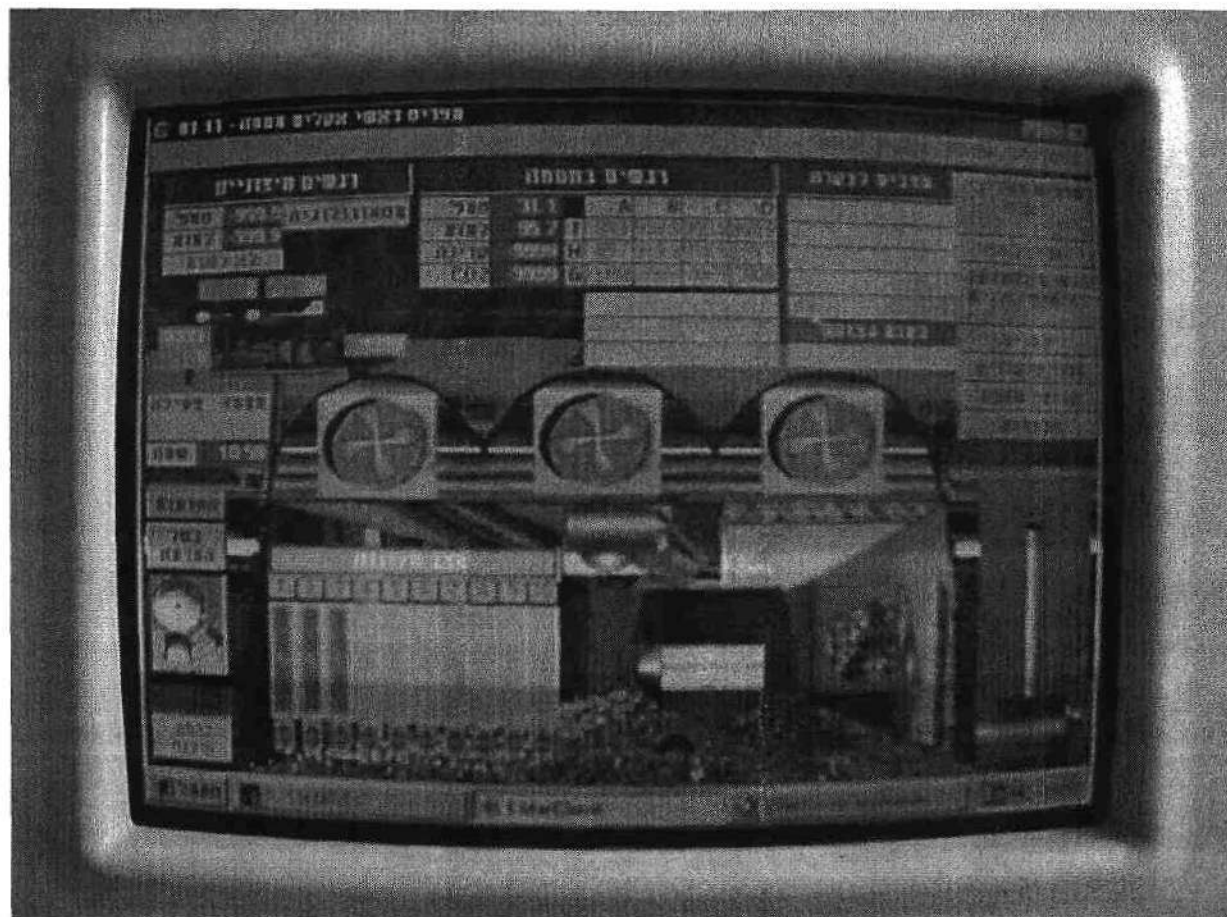

The second greenhouse viewed was more modern and intelligent. Fully automated, it has automatic opening/closing of roof and wall vents, fertigation, watering, heating all computer controlled. The computer bases its decisions on samples of water and from temperature and humidity sensors in the greenhouse. It sets the next irrigation and heating/cooling/humidity requirements based on the outcomes of the samples. This greenhouse uses the same size and type of media as the previous but has 3 instead of 2 lines of trickle tube. It has been found that this works better as they can get the same volume of water applied in a shorter time.

For heating, aluminium water tubes are used as they have found that the aluminium transmits heat better/quicker than the poly tubes. The downside is that maintenance costs are higher as the aluminium needs replacing more often.

The greenhouse is split into 4 sections in response to marketing changes and requirements for plant size, flavour and aroma. Each of the sections can be run at different temperatures and humidity to achieve the desired market requirement.

Night temperatures can be as low as 3 to 4 degrees Celsius, average night time temperature 6 to 7 degrees Celsius. The minimum greenhouse temperature at night is 17 degrees Celsius.

[Contents Page](#)

[Main CD Homepage](#)

Humid air is extracted at the top of the greenhouse via automatic blinds.

The optimal temperature for Basil is described as 'moderate' which in reality is 17 (minimum night) to 24 (minimum day) degrees Celcius.

Humidity is very important in this greenhouse – it can be the same temperature as outside but humidity is much higher inside. Higher roves allow better control of temperature and humidity in greenhouses, i.e. 5 metre roof heights.

Greenhouses actually grow crops in 'volume' not in square metre of ground area. The verandah area of the greenhouse is there for a few reasons; 1. for a service area, 2. structural strength and 3. cheap extra space/coverings.

Setup:

Entire floor of the greenhouse is covered in plastic.

Hygiene is the key to keeping bacteria out of the water supply, but the bore water used has little or no bacteria.

Two mixes of fertilizer are used A and B, and these are mixed in the ratios needed to supply the crop with nutrients (as required). There are three injectors supplying the hydroponic beds.

1. Acid (pH), 2. EC in media, and 3. for outside crops.

## **Day 2 – Second stop:**

### **Field Corn: Israk Skirtsken – Row Crop Corporation, Gilan**

Sweetcorn varieties grown, Jubilee for Industry and Dynasty for the fresh market.

The sweetcorn were to be harvested at the end of the month. Aphids have been the biggest problem this growing season and for this the growers sprayed once!

Heliiothis is not a big problem in corn in Israel.

Production average is about 8 tonnes/Ha, (may have been 8 tonnes/dunam = 80 tonnes/Ha?? – Can a sweetcorn producer comment on this – what is the Australian average?) grown with 5 Ml water/Ha allocation, using 3Litre/hour drip irrigation.

Evaporation is approximately 10 mm/day therefore irrigating 11 mm/day.

Dynasty has a higher sugar level than Jubilee.

The sweetcorn is mechanically harvested with one of two machines depending on the market. 1 machine for export and one machine for industry corn.

Harvesting 20 tonnes/Ha of Jubilee and 1.5 tonnes/Ha of Dynasty supersweets.



Tomatoes for processing:

1<sup>st</sup> crop planted in mid February (coldest month) – seedlings planted.

Using Super Typhoon 125 tape – 0.4 metre spacing, 1 litre per hour. Tape is used top grow crops for three years. Twice in corn (where it can be rewound) and the third and final year in tomatoes after which it is thrown away.

After working up the bed, the seedlings are immediately planted, tape unrolled and seedlings given a 5mm irrigation to get them going. Where the soil is poorer growers use 0.25 metre dripper spacing, irrigating using 250 cc per hour, using a lower pressure. With this scenario growers got the same levels of establishment as in better soils.

Generally farmers are going to closer spacing, lower flow rates and getting better establishment levels.

No plastic is used and no methyl bromide.

Two irrigation lines in the tomatoes, 30 cm apart, rotary hoe between the beds with Treflan. Shielded spray is used between the plants on the bed. As the tomatoes grow they shield out the weeds on the bed.

The producer is contracted with a committed price to the processor – when asked if he had a contract, replied “of course”. Growers get \$61.00 US per tonne – with a percentage for high brix content. Yield is 100 – 120 tonnes/Ha.

An experiment conducted on this property: had 2 seedlings per row (only 1 row – same amount of plants). Planted right beside the tape, therefore less water required. The plants received 5% less yield but the positive side was that production was easier and cheaper.

Further experiments were planted in saline soil, same experiments but brought in the rows from 190 to 160 cm. The drip line was placed slightly under the surface, harvester running 2 cm below the surface.

Sub-surface irrigation – cotton/corn/tomato rotation – ORGANIC.

Use ordinary 1 inch drip tape buried 40 cm below the surface. Using reclaimed water for irrigation – good to use as the water does not touch the crop. Using mulch (dairy manure) on the surface – turn in the mulch once a year – use a 120 hp tractor for the non-organic block and a 90 hp tractor for the organic block.

Chick peas (organic), Bulgarian is the most common variety grown. Lateral 1 metre spacing, emitter spacing 0.5 metre. Yield 4.5 tonnes per hectare. Growers do not spray for heliothis.

## **Day 2, Third Stop, Kibbutz Bet Hashitta (1,300 Hectares – about 600 under crop at any one time), Grower, Yaron**

Cucumbers grown under drip in the field, 2 crops per season.

Early season crop planted early February. Ground preparation, plow soil, placing a hollow in the centre of the bed and place drip line in the hollow, seed in the hollow and cover with plastic.

The grower gets 5 weeks growth before ‘normal’ field grown cucumbers.

[Contents Page](#)

[Main CD Homepage](#)

Benefits include:

- Kills weeds
- Increases immediate area warmth
- Keeps roots warm and humid

Very early method of growing cucumbers. According to the grower it “helps keep plants happy”

When the Cucumbers are flowering, they bring in the bumble bees to aid pollination – Bees are very important at the first flowering – 2 ½ boxes per hectare (60 bees/box). Keep water up to the plants – as much as evaporation, i.e. if 11 mm of evaporation, water 11 mm.

They fertilise with the irrigation every day, and spray once a week for mildew and thrips.

Harvest – size is paramount – need 18 to 25 cucumbers in a 325g tin (for pickling).

Weed Control: 20ml goal plus 200 ml Glyphos plus a little soap per 100 litres – only weed spray during winter. There are no weeds under the plastic, as they are burned off by the sun.

Yield: 2 to 2 ½ tones per dunam (20 to 25 tonnes per hectare) of the required size cucumber.

Fertiliser: Superphosphate – 10 units, phosphor (?) 4 units, 4 units of Nitrogen and when harvesting ½ unit/day Nitrogen and potassium (KNO<sub>3</sub>).

Have 15 workers picking per day per hectare.. Workers are paid on a per kilogram basis.

If the crop requires pest/disease spray it is sprayed from a ground based boom.

Return to grower: Number 1 size - \$2.00/kg (AUD) and there is 50 cucumbers in a kilogram.

Yield can be up to 50 tonnes/ha of all sizes (not just the ideal size).

The Kibbutz has found that the least problematic/most efficient method of harvesting is by families. The grower allocates 5, 70 metre rows to harvest per day/family. This is not necessarily Kibbutz members – more often contracted labour.

The Kibbutz can have major problems if the authorities close the border to the West Bank (Arab labour) as crops must be harvested when size reached – one day late can be disastrous for required size yield.

The Kibbutz only grows for market. I.e. tried to grow and market yellow zucchini – beautiful shape, colour etc but not what the market wanted. Market said “if it’s yellow, we eat bananas”.

The Kibbutz also grows corn, garlic, sunflower, pearl onions and silage.

The grower stated, “If we don’t have recycled water in Israel, we don’t grow”. Farmers are soon to pay more to use it. \$240 a megalitre current cost, kibbutz has a 5000 Megalitre allocation, Israel Government wants to up the cost to 40c AUD per cubic metre of water - \$400 AUD per megalitre. Kibbutz gets 400 mm of rainfall per year.

#### ***Grower Comments:***

*Growers had positive and negative comments about some of the types of farming listed above. Generally the herb farm was found interesting, with the harvesting, post-harvest handling, storage and packaging well set up.*

*The sweet corn yield seen in Israel yields 8 tonnes to the hectare – In NSW, a good maize crop yields 31/2 tonnes per acre (slightly more than Israel).*

[Contents Page](#)

[Main CD Homepage](#)

**Day 3 – Ashqelon, AZROM, Shany Eldar Gal controllers,  
Yosef, - Technical Support Manager**



The company has been active in the greenhouse/irrigation control area for 20 years. Started in poultry sheds now mainly greenhouse irrigation.

Company deals with 2 main areas:

- Control systems
- Analytical systems

R&D – Electronics, Software, Radio control

Production:

- Open field irrigation
- Soilless fertigation
- Greenhouse climate
- Gardening
- Poultry houses

Marketing:

- Export
- East Asia and USA
- Africa, East and West Europe
- Middle East and Oceania

Controllers: Main Products

- Agro-8, low cost battery powered irrigation control

[Contents Page](#)

[Main CD Homepage](#)

- Gal Compact, open fields irrigation, AC or DC powered
- Sigal II, filter flushing control
- Eldar Controllers, Modular systems, for greenhouses, open fields, poultry
- Eldar CO<sub>2</sub> Controller

Accessories: Sensors, temperature, humidity, wind, sunlight, pH, EC, soil moisture etc.  
Fertiliser pumps, terminal units for open fields, communication cable, radios etc, net protection, adaptors.

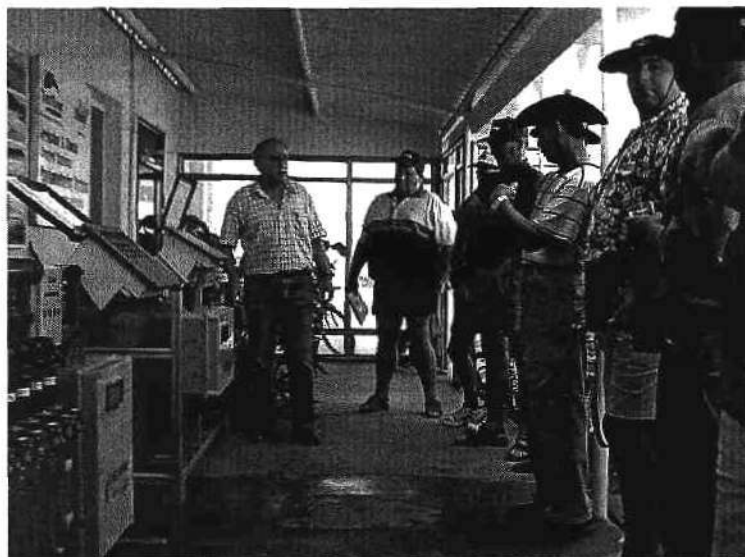

Systems, Fertigation systems, Ometz (now renamed Fertimix), fertigal, drainage sampling, fertiliser dissolvers

Software: Application programs, PC central control programs, Winman data logging program.

Can use 1 sensor for up to 20 greenhouses – using the scanning program.  
90% of expenses in R&D are in software.

Computerised systems for Agriculture – Why do we need it?

Savings in direct inputs, H<sub>2</sub>O, Energy, Fertiliser, Insecticides and Labour.

Maximising yields, quality improvement, management improvement, early alert of problems, environmental protection (saving fuel, chemical use, H<sub>2</sub>O etc)

Computer inputs: Temperature, humidity, wind speed and direction, sun radiation, CO<sub>2</sub>, pH, EC, rain, water quantity, fertiliser quantity.

Computer outputs: Valve control, fertiliser pumps, water pumps, greenhouse windows, fans, screens, motors, foggers, heaters, CO<sub>2</sub>, sprayers and humidifiers.

Program Characteristics:

100 irrigation programs with the following settings in each.

Time based, H<sub>2</sub>O settings, daily interval, irrigation start time (5X/day), cyclical irrigation (optional) – operation and waiting time. Operation by conditions (dry contact, sensor's value etc) High flow alarm, low flow alarm, low pressure, uncontrolled H<sub>2</sub>O alert, 1 to 4 control valves, select fertigation program (out of 20 programs).

[Contents Page](#)

[Main CD Homepage](#)

20 fertigation programs: to determine in each;

Fertiliser concentration (lt/m<sup>3</sup>) per 1 to 8 injectors, injectors definition (EC or pH), EC required (automatic adjustment), pH required (automatic adjustment), water before fertiliser, H<sub>2</sub>O after fertiliser, high EC alarm, low pH alarm, Uncontrolled fertiliser, unexecuted fertiliser.

**Day 3 Visit 2, Moshav Shequev.**



Grow cherry tomatoes in Greenhouses, Variety 819, and use very little water to keep small for the market. Sold on price per weight. Grown using the same hydroponic setup as the herb grower seen previously.

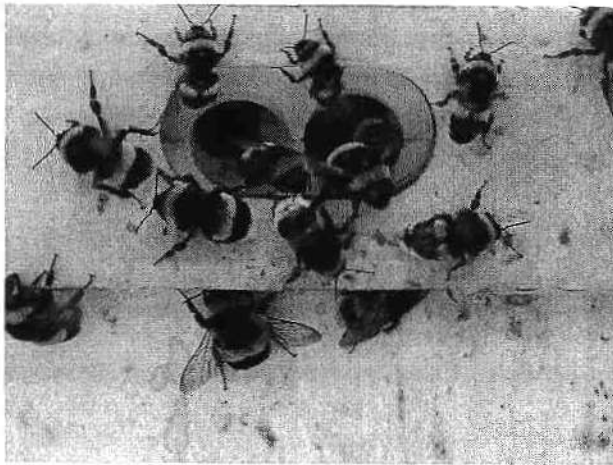

Bumble bees (*Bombus* spp.) used for pollination. If the greenhouse is too hot the bees won't work. Biobee is one of two commercial suppliers of bees. Bumble bees, as their names

[Contents Page](#)

[Main CD Homepage](#)

suggest are clumsy fliers and are 'turned on' by the colour blue and strong perfumes. Flowers visited/pollinated by the bumble bees show a brown spot on the flower centre region.

Biobees are booked early in the season – the grower knows when his crop will flower so they book the bees well in advance. The Biobee consultant will book the bees for a month in the greenhouse. Food is initially supplied with the colony - there are about 60 bees plus a queen in each colony. Growers can use hormones to assist pollination but generally bees are the best method. When manually assisting pollination (shaking the plant) get the timing correct in the mornings – to ensure that the pollen is dry, but the ovary (stamen) is wet.

Trellis – can grow the plants as high as they need, plant at 2.2 plants to the square metre. Irrigate 3 times a day. On a very hot day, irrigate a little more but not much as the grower wants the fruit to remain small. 'Normal' tomatoes are watered up to 8 times a day. EC of the water is 0.7 – basically drinking water.

Tomatoes are planted at 2200 per dunam (22,000 per hectare) and have 6,600 stems per dunam (66,000 stems per hectare).

Fertiliser is applied per portion with the water.

Hydroponic media (scoria) is in 3 different sizes, on the top they are small, middle medium and on the bottom of the system are large. Drainage runs in the trough itself.

The greenhouse has a double vent roof. The insect proof net is periodically blocked by dust and must be cleaned by spraying with a hose from the inside out.

Pests: Main pests are leafminer and red spider mite – however the growers apply very few sprays. This season they have only sprayed once for whitefly and rust spider mite. The growers monitor the crops with yellow sticky traps, and as soon as pests show on these, they spray. Insects can be huge problems so they must spray immediately if a pest species shows up.



The greenhouse has 'antivirus' plastic on the roof and blue and yellow striped sticky plastic on the skirts of the greenhouse. The skirt plastic is sprayed with glue and insects such as Western Flower Thrips are attracted to this over the crop and stick to it – the growers have found this to be most effective in controlling this pest. The mix of blue and yellow plastic also attracts the whitefly pest.

For soil sterilization, metham sodium is used through the trickle tape (after beds are covered with plastic) This grower had also used formalin through the foggers in a sealed greenhouse. This is however, only done when problems have been identified in the greenhouse.





**Planting setup/training:** The plants are trellised and are all trained/leaning in one direction in each row – the plants in the next row will lean back the other way. This allows ‘taller’ plants for increased production

**GROWER COMMENT: Boris Stoeff.**

*“This is the best experience I have had” In Holland they close their glasshouses – here they open their greenhouses. Points of interest are:*

1. *In Australia 100% of growers are going to have to build their greenhouses high (4 metre gutter height). Now they are 2 metres and when the plant grows to the glass or plastic and it is hot, the crop/plant burns. When it is cold the plant freezes. The current (main design) used in Australia creates lots of humidity which can't be ventilated or adequately controlled. If we go higher – say buy 5 metre posts – they will only cost an extra \$6 AUD each and we can make higher greenhouses.*

2. *The increased roof height gives a larger volume and hence a more constant temperature – it may take longer to heat. This will also reduce humidity and cause less fungal disease. Boris could not see why Australian growers should not adopt this technology.*

3. *For Western Flower Thrips: As illustrated by Israeli greenhouse producers, you must have a weed free zone around the greenhouse, must use insect viral plastic, Predatory mites such as Ozzie 1 must be bred up and available (suitable species) for use in greenhouses, must spray the sides of the greenhouse (lower blue/yellow plastic strips) with tanglefoot or similar to keep WFT out of the crop, must use insect proof netting. All of these have been used by the Israeli growers and they do not have WFT problems!*

**GROWER COMMENT: Geoff Skuse.**

*On the pollination aspect, Australian growers should have access to the Bombus species of bumble bees.*

*Greenhouse structure – it is important that if the grower has tall crops that they have a high roof. In Australia we presently open up the greenhouse to keep it/the crop cool – we must use methods such as insect proof netting to stop pests such as WFT destroying crops.*

### **Day 3 Visit 3 Soloshtil, Moshav Shar (Sunset)**

Rose production: Harvest the stems twice a day, every day. Greenhouses heated via aluminium pipes. Has internal thermal mesh. The whole place is constructed as a giant air conditioner as in rose production it is important to minimize humidity.



Chemical sprays for pests or disease are done when the greenhouse is empty. They use the fogger system, computer controlled system mainly used late afternoons after the last harvest is completed.



Shed cost \$100 US/square metre to construct. The entire production is for export to Holland. Shoots that are not wanted are 'pushed down' to promote apical dominance.

**Day 3 Visit 3, AZROM production facility (no photos) Next to Gaza Strip.**

**Grower Comments:**

*The Eldar Shany control and analytical systems definitely have a ready market in Australia.*

*The Bumble Bees (as against *Apis mellifera* – the 'honey bee') were seen as essential to effective greenhouse pollination. The growers were all for having them in Australia – it was pointed out that they had been illegally released into mainland Australia – they believe that companies similar to those providing Bee Services in Israel should be established in Australia.*

*The way the bees are controlled in the Greenhouse environment should enable their use in Australia. Realistically, the growers thought that they would be manually assisting vcrop pollination for some time yet!*

*The rose greenhouses were very interesting for only a few growers, however the greenhouses were set up as a giant evaporative air-conditioner – one wall was 'wet' with the opposite wall having giant fans to draw the air through the centre of the greenhouse.*

*AZROM greenhouses have a definite market in Australia – there are a lot of growers who brought greenhouse technology with them from Europe in the 1940s and 50's and have not made much improvement since. Gutter height is seen as a major point – Australia's average gutter height (hence internal volume) is 2 metres. The lowest gutter height seen in Israel was 4 metres. They grow in a cubic volume – not on a square metre basis.*

## Day 4, Hbsor Research Station, Western Edge of the Negev Desert.

Research station has 8 permanent staff and 20 casuals.



### Trialling:

- Tomatoes, Maman variety
- Varieties of cucumbers and tomatoes for representatives of Israeli seed companies
- 4 types of company supplied greenhouses

### Research Selection and Methodology:

Growers are invited to put in proposals for R&D in their region. There are research stations in each production region.

The research stations are Government funded (infrastructure), but are run by the local council with a community trust as the board.

Hannah, R&D Agronomist in charge of Vegetable Experiments at the South Hbsor Research Station (Hbsor = South Creek).

The Research Farm is 25 years old, Hannah has been working there for 8 years. Supported primarily by the Government and the Volcani Centre.

The researchers look for the best team to work with to ensure success and implementation of the research. Trials are conducted on the station and on growers properties. Most research conducted is practical, not purely scientific.

The Ministry of Agriculture assist in promoting liaison between growers and the research centre.

Growers are always welcome at the research station.

The centre has a big open day once a year and all researchers are present for the day to explain their findings and the adoption methodology.

When a research project is finalized, the Researcher calls a grower meeting to deliver the results. Growers are also encouraged to attend the centre during the research to ensure outcomes will be applicable to their farming enterprise.

Local Council also helps fund the R&D station.

Most research is conducted in the greenhouses, some in open fields.

Apart from the work conducted with peppers, tomatoes, a new system of growing strawberries,

[Contents Page](#)

[Main CD Homepage](#)



introduction of new products, the researchers are looking at types of plastic greenhouse covers, biological control, climatic conditions, water recycling, rose and strawberry irrigation methods, biological controls for fungus and MeBr replacement.

**Prioritising Research:** Delegates from the grower base, Research institution and Department of Agriculture decide on the research priorities for the year. Growers pay less than 0.5% ad-velorum levy to help fund the research.

Azrom and 5 other greenhouse manufacturers donated greenhouses to the R&D station, and other companies donate new technology products to the station to be evaluated and exposed to the growers.

The researchers prefer to conduct research at the centre, but will do it on grower properties. Agronomists are Government supplied, but recent cutbacks are leading to more private consultants in the field. More often than not these are ex-Government employees. There is no cost for the Government supplied agronomist to go to farms.

Evaluation of new products include: Chayota (choko), new introduction from latin America, smells like kohlrabi and shaped like a pear. Peter Anderson (Netafim) added "it tastes like a glass of spit" Another new introduction is 'shusha' which is like a cucumber, but a hollow type with just one line of seeds.

**R&D on/in greenhouses:** Greenhouses with opening roves (comparative R&D). Current research on 4 greenhouses supplied by different companies with different styles of roof openings (different widths). This is not only important R&D for the companies, giving feedback on the design to the suppliers but important also for growers who want to purchase the best suited design for the crops they wish to grow.



Peppers grown in the greenhouses are of the Kobi variety. 16kg per bush per metre squared.

[Contents Page](#)

[Main CD Homepage](#)

Yield is 160 tonnes per hectare – this includes the total covered area including paths. Watered via a 2 metre pipe straight from the Sea of Galilee – farm take-off from this pipe. Fertigation is used for the crop.

Capsicums: grown under UV plastic which causes whitefly difficulties in the greenhouse – essentially they can't navigate or 'see' the crops effectively so can't survive. R&D is ongoing into the additive in the plastic that causes UV to be absorbed in the plastic which results in less insects in the greenhouse.

Trial area for this includes 16 greenhouses of ¼ dunam each (2,500 square metres). All of the greenhouses have nets and covering plastic with different rates and colours of the UV absorbent chemical.

The greenhouses have had no chemical spray control. In the control greenhouse, with no UV chemical, the crop has suffered from whitefly and associated virus. Part of the research is also looking at the UV chemicals disturbance of biological control agents. Predatory wasps, thrips and mites have all worked well under the UV plastic.

Powdery Mildew is also a problem and the researchers are looking at a number of control methods including, a biological method of control, evaporating sulphur and other methods.



Second greenhouse: Peppers growing on hydroponics, scoria media. Project is to see if increasing CO2 levels in greenhouse increases yield. CO2 fed by large external tanks fed into greenhouse by poly pipes. Investigated feeding in hot or cold CO2 gas with 1 greenhouse for control (no CO2).

Found that the CO2 increased yield by 30% but was not particularly cost effective for the cold gas. Hot gas trials will continue but it makes the greenhouse hotter – up to 30 degrees Celcius

[Contents Page](#)

[Main CD Homepage](#)

and increases humidity to 90% but the pepper plants were fine growing under these conditions. Using the hydroponic system, the researchers can undertake full measurements of the plants growing requirements. Trial was planted at the beginning of September 1999.

Bees are used to aid pollination of the peppers, different supplier to the first one seen. Get approximately 100 bees to the hive including the queen. The hive will live for three months during winter and 2 months during summer. If the bees escape the greenhouse they will try to get back in as they identify with only one hive. Costs approximately \$100 AUD to buy and service during the flowering season per hive and one hive will pollinate 2000 square metres of greenhouse.

Third greenhouse: Strawberries, hydroponically grown on raised beds with no chemical sprays (apart from sulphur). It must be added at this point that these were the largest, most succulent, tasty strawberries most of the tour participants had tasted.

Yield 13 kilograms per metre squared – 130 tonnes per hectare. 11 plants per metre. Light conditions are imperative to the success of strawberry production. Planted 20<sup>th</sup> of September 1999 and first harvested 10<sup>th</sup> of November. Had harvested 4000kg to the end of December and received \$11 AUD per kg for the first pick. This is an excellent return.

The variety grown (Israeli 328, Amargh) is expensive to buy but returns are fantastic.

Initial experiments were with 11 plants to the metre but also tried 22 plants to the metre but this did not justify the initial cost increase.



1<sup>st</sup> season the experiment returned and extra \$5,000 AUD after all costs were covered on a 4000 metre squared trial area. The variety used is a short day variety, and it must have the correct chill factor to be grown as the varieties can be sourced from the desert or the mountains.

Southern Research and Development was the first regional R&D establishment in Israel During its first years it was mainly involved in the development agricultural branches in the early settlement in North Sina

Following the peace agreement with Egypt, the Southern R&D activities were removed to the western and northern areas of the Negev, and now its activities are focused in the local councils of Eshkol, Gaza plain Merhavim and Azzata Regional Council

The Southern R&D organization. operates under a collaborative auspices of the JNF (Jewish National Fund), The Ministry of Agriculture, including the Volcani Center and the Extension Service. The Settlement Department of the World Zionist Organization and the farmers of the western Negev

By definition the regional R&D deals with solving current regional problems. characterising agriculture in these areas, and with long-term development of advances production technologies and introduction of new products, utilizing the relative advantages of the region

The southern research and development activities are focused mainly on intensive crops

- 1 Vegetables
- 2 Flower
- 3 Ornementals
- 4 Herbs
- 5 Citrus

The first 4 subjects are dealt with on two levels:

**a. Development of advanced production technologies in greenhouses:**  
for example

- CO<sub>2</sub> enrichment
- Cooling methods, to improve the yield and crop quality in the summer
- Optimization of heating regimes and photoperiodic lighting in newly introduced cut flowers
- Water saving by the use of recycled sewage water and prevention of soil and underground water contamination with salts.
- heating of growth media
- Detached media
- Plastics
- Use of nets to exclude insects.

**b. Introduction and development of new products**

**Vegetables** - Heated quality pepper for winter export  
Strawberry — directing flowering and increasing crop by using advanced production technologies  
Tomato new products of specific shape and color, cherry tomatoes, clusters etc.

**Flowers** Continuous introduction of new varieties (about 45% of the regional flower selection is based on newly assimilated varieties that were introduced into the region in recent years) including Solidago, Lisianthus, Limonium, Hypericum *Asclepias tuberosa* *Asclepias cinderella* Trachelium etc.



- Ornamentals** - Introduction and development of flower varieties mainly from the southern hemisphere for flowerpots
- Citrus** — Currently, the Citrus branch is at the beginning of a transition process to the Negev. Irrigation of these orchards will be based on recycling sewage water plant in the Dan coastal plain region. The expected future salinization of this water, necessitated examination of various Citrus stocks resistance to predicted rates of water salinity.

The main R&D activities are conducted at the regional research station in the Besor farm. in collaboration with researchers from various research institutes in Israel (The Agricultural Research Organization, The Hebrew University of Jerusalem and Ben-Gurion University) Instructors of the Negev extension service and regional farmers are also involved in R&D activities. contributing their advise, thoughts, performance and funding

In recent years the Southern R&D was involved in the development of various fields, that are already implemented in the Negev farms as well as in other regions in Israel These developments include.

#### **Technological developments:**

1. Nets against insects to reduce the infection TYLCV in tomatoes.
2. Use of wild bees to improve tomato ripening in the winter and save many labor days
3. Plastics use of polyethylene sheets that contain blocking UV radiation additives to exclude various pests (tobacco moth aphids, Californian thrips), and to reduce the usc of infesticides
4. Obtaining early flowering of wax flowers by short day regime
5. Establishment of heat and photoperiodic lighting regimes in newly introduced flowers, such as *Asclepsis tuberosa* Trachel mm, Li si anthus, etc

#### **Development of new crops**

1. High quality pepper for winter export.
2. Strawberry production using advanced technologies.
3. Introduction of new flowers, which coml)ries a large part of export flowers, such as Solidago. Hypericum Lisianthus and others.

#### **Day 4 Visit 2, Greenhouse Tomatoes, Mivtahim, Yossi, grower**

Crop planted 20<sup>th</sup> of March. Variety 1402, Kamara, which has immunity to fusarium and nematode. It should be noted it is resistant to fusarium strains 1 & 2 but not strain 3 therefore not good for Australian conditions.

Methyl Bromide is put through the trickle system, covered with plastic and left to solarisation for a few months.

The MeBr is heated to 80 degrees Celcius at which point it becomes a gas and it is run through the irrigation tapes below the plastic covering the greenhouse floor. Plastic left for 3 weeks at

an absolute minimum, usually much longer to get the sun's effect.

Direct solarisation only occurs in summer. Cover the ground in the greenhouse with plastic and apply small amounts of water every 2 weeks, causes the 'bugs' to grow and the heat kills them (this must be kept up for three months).

#### Second Greenhouse

50% mesh on greenhouse but can change if need more light/heat. Tomato variety 916 which is 80% resistant against the whitefly vectored Gemini virus called yellow shoot virus in Israel. This is a new variety for SA and Boris Stoeff is the agent. Size of the ripe fruit is 180 to 250 grams. Can train the bush to be 1, 2 or 3 stems or just a bush. It is a very aggressive plant and can get 10 to 12 tomatoes per cluster – ideal for vine ripened tomatoes. When harvested, the calyx can stay green for up to 10 days. Yield is 15 to 20 tonnes per dunam (150 to 200 tonnes per hectare).

Next variety looked at was 1123, which is 100% resistant to nematodes (similar to Graetziella in Australia). A strong, aggressive plant with mature fruit size between 150 to 200 grams with good taste. Not resistant to whitefly. Yield 25 to 30 tonnes per dunam (250 – 300 t/Ha)

#### *Grower Comments:*

*Hbsor Research Station was seen as a highlight. The growers felt the tomato and strawberry production techniques were extremely interesting.*

*A number of the growers were going to follow up on the hydroponic strawberry production techniques when they returned to Adelaide. As a result of the tour, at least 2 growers have set up trial strawberry plantings based on the Israeli methodology.*

*There was a little confusion with the number of greenhouses on the research station and what they were trying to achieve – although I feel that it was due to the pressure on the Hbsor researchers trying to get across a great amount of information in a short time. The greenhouses were for comparative research – with regard to air-flows and humidity control and the best crops to grow in each type of greenhouse. It was not about which greenhouse was 'better' – it was which crops grow best in each type of greenhouse.*

*At least 2 of the growers were going to purchase an AZROM, 'Negev' style greenhouse on their return to Australia. To quote Bill Elliott "This unit is so much better than anything I've seen in Australia". It has distinct advantages such as internal temperature/humidity being easier to control than the others seen and it is easily insect proofed. The higher roofing and better ventilation will reduce humidity. This aspect alone will (should) reduce or eliminate pesticide spraying, reduce fungal sprays and be kinder to workers.*

*The strawberry production shown to us definitely has a place in Australia – but could cause the market to be oversupplied.*

**Day 5, Kibbutz Yoteva – Research Station. Amnon, Director of Experimental Station.**



Research Station has been functioning for 40 years – to enable growers to survive in very extreme conditions. Climatic conditions for the region include very hot summers – extreme desert conditions. The region can suffer from sandstorms in summer and spring. Average rainfall is 1 inch per year. Last years total rainfall was 1 mm. Evaporation is also very high – approximately 3,300 mm per year for the Southern Arava, 3000 mm for the Central Arava, 2,300 mm for the Ramat Negev and 2,400 mm for the Jordan Valley. Bore water is very saline 3.5 ds/m (EC) for the Southern Arava, Central Arava has 2.1 EC, Besore 1.0 EC, Jordan Valley 1.2 EC, Ramat Negev 1.0 EC.

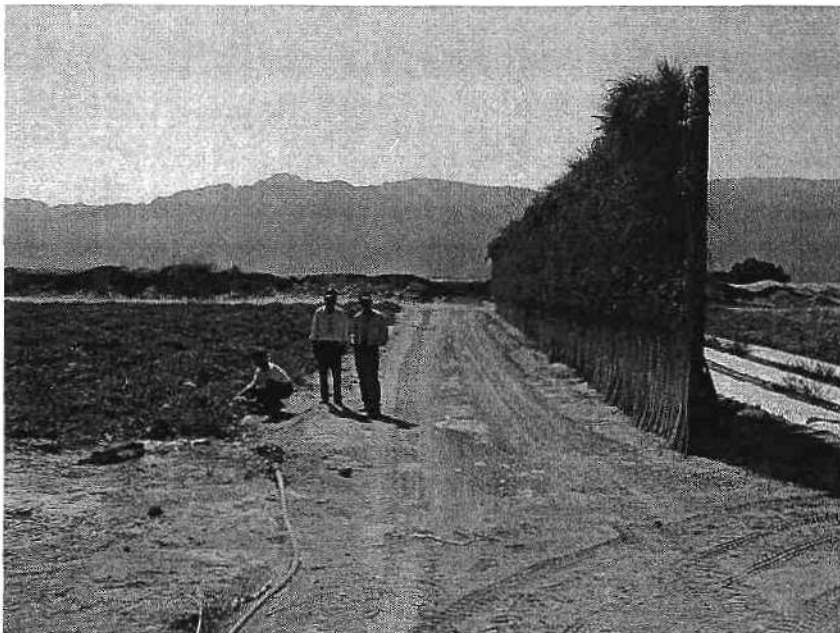

Most experiments conducted on the station are to manage vegetable trees and cows under these extreme conditions. Essentially the more salty the water, the less yield obtained. Even feeding cows in Besore versus Arava, cows drink 10 litres per day more and give 2 litres per day more

[Contents Page](#) [Main CD Homepage](#)

milk.

The first revolution investigated and implemented from this research station was that of drip irrigation. The first scientific R&D in the world on drip irrigation was conducted at their research station in 1964.

To irrigate normally would burn the leaves.

Experiments on the station include watermelons looking at salinity and balance of water in the plants and crop, musk melon and Endor varieties. For watermelons they try to adapt new varieties to the extreme conditions – planting ‘normally’ occurs in spring time in the open fields. Watermelon trials – seedless variety 313, pollinator is Crimson sweet.

Plant this variety in winter (15<sup>th</sup> of January) in small tunnels of plastic with holes cut for the plants, increase holes in size as the temperature increases and remove plastic in February. Irrigation occurs according to daily evaporation and the crop is harvested at the end of April through to early May. Yield is 7 to 9 tonnes per dunam (70 to 90 tonnes per hectare)

The soil is fumigated with Methyl Bromide at 20 to 30 kg per dunam. Winter temperatures fall as low as 6 degrees Celcius and minimum Summer temperatures are at about 25 degrees Celcius with daytime temperature in the 40’s.

Water and fertigation occur to the demand of the plant – and the salt input from the fertiliser is not considered important.

Date palm windbreaks are used to minimize wind/sandstorm damage.

Water/Salinity research: For measuring this in controlled circumstances, sophisticated tools were constructed to measure the balance of plant requirements against evaporation. For salty water (if very high EC) plants use less water and subsequently the growers get less yield but the plant survives. The plants lose water by transpiration and evaporation so the researchers are also looking at the relationship between these aspects. Researching the differences between open and closed canopies of melon plants.

This research is being conducted on melons, peppers, tomatoes, sunflowers, date palms, and irrigation water for these experiments includes sewage water which contains a high percentage of boron. Currently the effect is not known for high salt and boron and research is being conducted into the long term effects of this to the plants and soil. Rates of boron looking at are from 0.1 up to 5 ppm.

Postharvest: Ava – Technician at research station.

Melons, variety 152, Ideal. Requirements for cut and packing melons.

[Contents Page](#)

[Main CD Homepage](#)

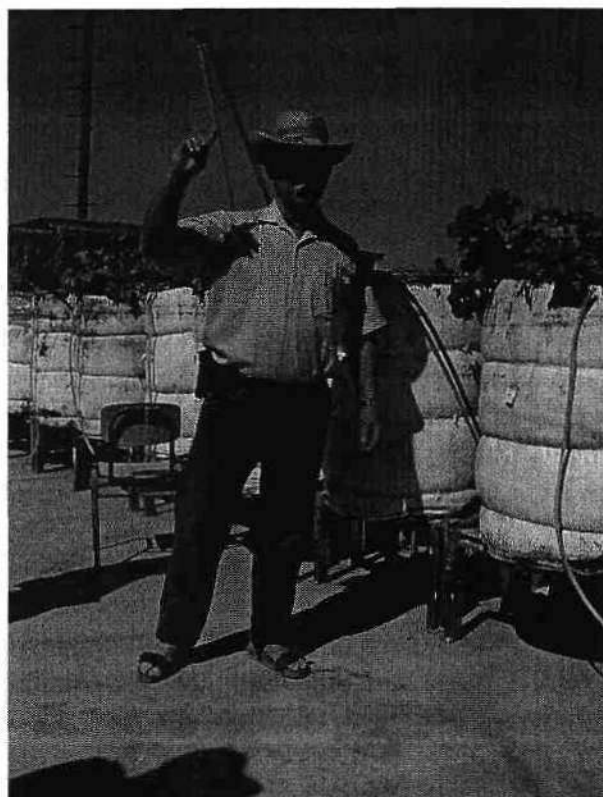

Calcium helps for firmness with the melon, no calcium takes longer to be melon. Netting on the melon is more course. Calcium in the bore water is 1,100 mg.Litre, EC of water 5.0 EC. Ideal amount of calcium is not known yet.



Sweetcorn is grown out of season, they market it early season for a price premium. Fields seeded in September and corn is harvested by December, or plant in January and harvest corn by April/May. The corn is harvested with combines.

Drip spacing, depends on vegetables, 30cm to 50 cm spacings. Output of drip lines is 2.5 to 4.0 litres per hour.

Vegetables: There is a very big advantage to apply water over a longer period – continuous irrigation. Get more yield when irrigation is continuous 8 am to 4 pm in 30 second pulses (very low volumes of water). There have been problems with blocking drips. Before planting the corn, the researchers plough grooves and do a technical irrigation to wash the salt through the soil profile.

Flowers: Grown for seed collection (as there is no rain makes collection easier). Also collect wildflower seeds for domestication (they had samples of Sturt's Desert Pea). Seed is collected mechanically (vacuum harvester), so methods of sealing the sand is important to minimize sand contamination. Different colored plastic is placed on the ground for measuring the temperature of the bed after application of Methyl Bromide.

Up to last year, the Government only allowed growers to use sewage water on dates, alfalfa – plants not for human consumption or where the water was not directly applied to the crop. The sewage water was from Eilat, a tourist city on the Red Sea.

The Government wants the growers to avoid free water evaporation – sewage irrigation water is not allowed to touch the fruit.

The research station is now doing R&D on grapes.

Experiments have been conducted with date palm leaves and plastic coverings on the soil to limit/eradicate evaporation, but the best has been trenching using a chain digger – 50 cm deep and 200 to 250 mm wide, 1 metre from the tree/vine line. The trench is filled with fine gravel or scoria with the drip line at the bottom of the trench – this stops all evaporation.

These trials have been conducted for the last three years and the researchers have not found any contamination – so the health authorities have changed their irrigation criteria for reclaimed sewage water.

Thus they have discovered with this method that reclaimed water is better than the local 'good' water used for irrigation.

[Contents Page](#)

[Main CD Homepage](#)

The level of boron in the reclaimed water started to be poisonous to grapes – so irrigate with pulses of 10 minutes on and 15 minutes off with very low outputs.

This is an expensive process to run – but the SA growers thought it would be a good system for tree/vine crops in Virginia.

Mangoes: Average yield for Mangoes is 1.5 tonne/dunam which increased to 3.0 tonnes per dunam using this method.

Where bores are used they are 200 metres deep, and drilled every km, further north the depth to the aquifer drops to 700 metres.

### **Day 5, Stop 2, Moshav Ein Tamar.**

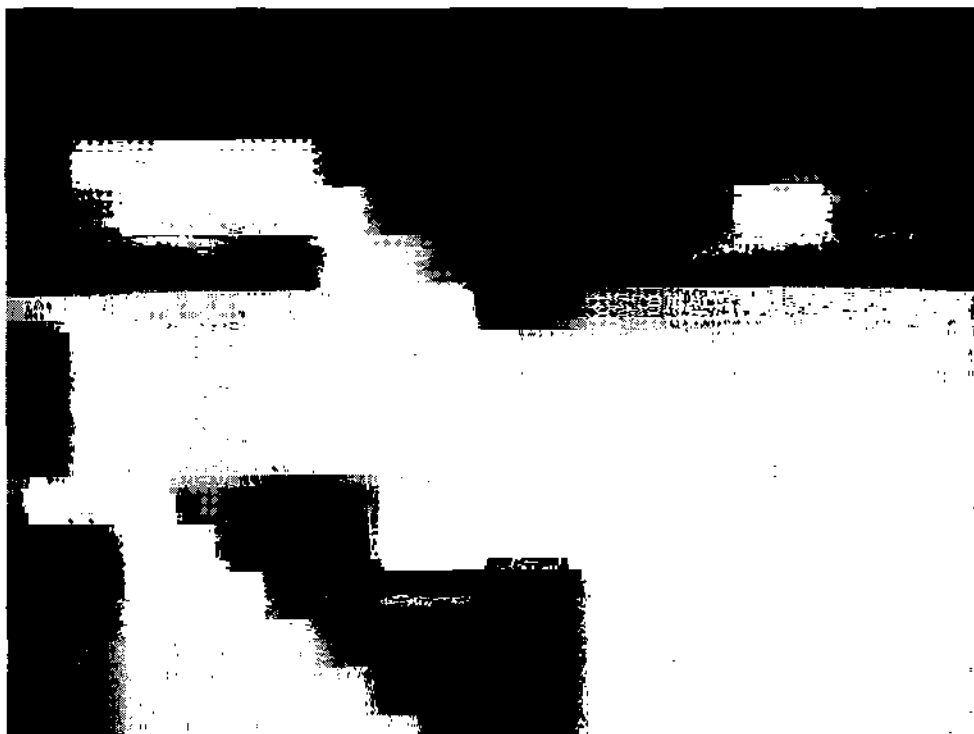

### **Greenhouse Tunnel Watermelons.**

Cost per setup - 7,000 Shekels per dunam.

Methodology: Arches are put in place, and transplanting begins mid December. Between 15<sup>th</sup> to 26<sup>th</sup> of December all are transplanted. Harvesting begins 26<sup>th</sup> of March – 1 month earlier than open field planted watermelons. Getting \$10 AUD per melon, average 3 shekels per kg. Crimson sweet gets 2 ½ shekels per kg and Seedless gets 4 shekels per kg.

The soil for tunnel use is MeBr treated under the plastic floor of the tunnel prior to use. There are 4 trickle lines per tunnel – tunnels are 80 metres long. If the crops in the tunnels require spraying they are sprayed from outside the tunnel through the holes cut in the side, using a 1200 litre tank.

Holes are cut in the tunnels to reduce heat (plastic is used once only) – the holes are enlarged as the daytime average temperature increases. For the first month of growth there are no holes, then a hole is cut in every third arch along the side, then every 2<sup>nd</sup> arch and so on as the heat increases. The growers have to slow vegetative growth, so they keep irrigation light as well. Plants initially look small. As the crop nears harvest, irrigation increases 10 to 12 cubic metres of water per dunam per day. The water is needed to fill the fruit.

[Contents Page](#)

[Main CD Homepage](#)

Downy Mildew is an ongoing battle. Powdery Mildew is controlled using Bayfidan. A mixture of mono potassium fertiliser and the chemical enhances the efficacy of the chemical.

1 to 2 sprays per season for caterpillar control using Endosulphan. Whitefly and aphids cause some problems but not every year.

Transplants are drenched in Confidor, but can't use this product after planting as the chemical can cause problems with bees and pollination. After pollination, Confidor can be used again if required for insect control.

Yield: 10 metric tonnes per dunam (100 tonnes per hectare) – the method gives high yields on new ground. Second year yield is down to 6 – 7 metric tones therefore the growers use a 3 to 5 year basis for crop rotation.

There is little point in planting earlier as there is market resistance to higher price and also the market only wants watermelons in the warmer weather.

Now 6 – 7 kg watermelons are getting 80 Argorots per kg (decimal system so less than 1 shekel per kg). The grower had tried exporting but will not get the money over the domestic market (if sell to Russia, the growers want the money up front).

Varieties grown are 303, 816 and 806.

*Grower Comments: Daryl O'Leary, QLD Watermelon grower.*

*It was totally unexpected to see watermelons grown in tunnels in the desert. I could see the reason of going to all the expense because of the early time of the year in which he harvests (the premium he is being paid). We could benefit from using the tunnels because of the cold conditions in winter, being able to expand the QLD season. Compared to the yields in Australia, under the tunnels the Israeli grower had much higher yields. On the down side, I feel that the labour costs in Australia would make it uneconomical unless you could receive a premium price.*

*A rough estimate of income vs expenses at a 4 shekel per kg return – for the area planted gives \$4 to 6 Million AUD clear profit above expenses.*

*There is no 'gamble' in this farming venture. The grower knew that by planting in the plastic tunnels, he would gain a one month earlier harvest window and premium prices starting at 4 shekels plus per kg. In Australia, my opinion is that labour costs are too high.*

*Expanding regional growing areas, such as this method offers may not be for Australians.*

*Australian growers are generally battlers and it is very easy to oversupply our markets.*

*Farmers in Australia all watch each other, and with good prices received for one season, encourages other farmers to grow the same produce. This generally means that the grower (all growers) receive lower prices the following season.*

*Israel has water supply problems and is a credit to farmers to be able to grow in the extreme desert conditions.*

**Day 5 Stop 3, Moshav Ein Yaar, Uzi Gadish, Moshav Elder.**



Last 3 weeks of the season for peppers and melons.

Moshavs have a central area where all members have their own house and a small selection of land. In addition each Moshav member is allocated 4 hectares in the production area of the farm. The Moshav has 120 families as members and farms 1200 hectares total. 500 hectares under plastic or greenhouses. To farm some of the new land the Moshav members had to backfill with 50 cm of soil and work this up.

Melons are grown in 120 metre long tunnels with plastic covers with drippers (also used for MeBr). This is a good production system for melons. Yield is 80 tonnes per hectare (as against 30 tonnes per hectare field grown – or grown on greenhouse floor – no trellising). The crop is planted in July and finished in October. Plant melons again in December and start to pick mid February until the end of May. A large percentage of the crop is exported to Europe, although the majority goes to the domestic market.

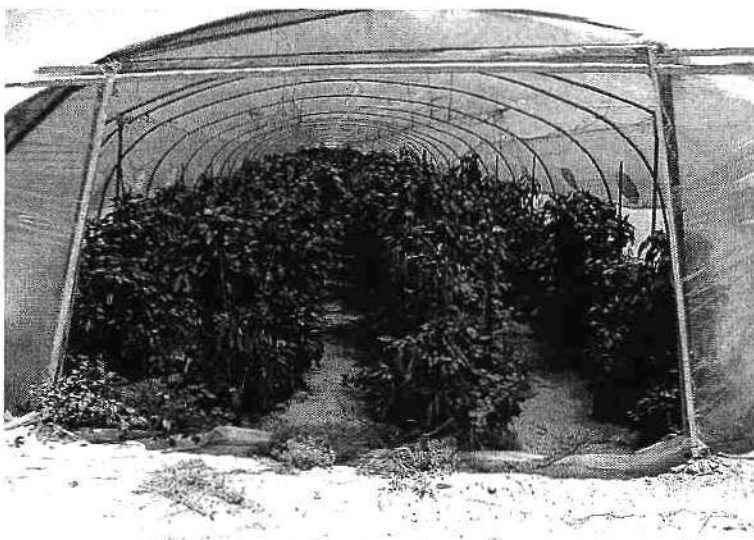

The poly is used only for one year (all plastic). Green waste can be recycled/composted. The plastic can also be recycled, but the recyclers want it washed and the growers find this difficult



to do – so the growers do not often take up the option.

Peppers: 140 to 160 tonnes per hectare Pest and disease problems include whitefly, California thrips and powdery mildew.

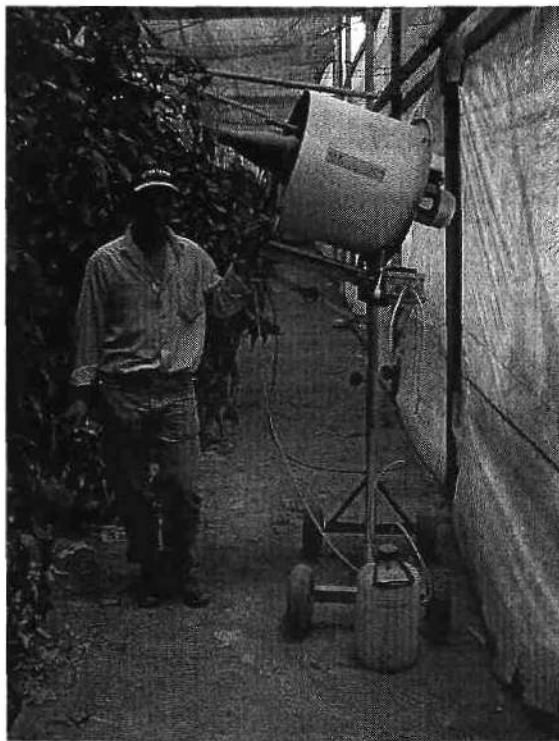

Growers start the fogger machines at night when the greenhouses are empty to control pest or disease problems. Fans in the roof space of the greenhouse are kept on for 6 hours whilst fogging to spread the chemical throughout the greenhouse. Fans are in 180 degree direction to each other in adjacent bays to ensure the best spread of chemical in the greenhouse.



Pepper colour mix grown, 60% red, 30% green and 10% orange. 60 to 70% are grown for export from the tunnels. 90% of peppers grown in the greenhouse are exported. Tunnels (120 metres by 6.2 metres) have 4 rows of pepper plants, planted on the 20<sup>th</sup> of August, harvested on the 10<sup>th</sup> of November. In Spring a shade net is put on the tunnels and holes are cut

[Contents Page](#)

[Main CD Homepage](#)

in the plastic to keep the tunnels cool. Yield is 60 tonnes/Ha.

Peppers are on Spanish trellising, with 2 lines holding the crop off the ground. The melons are grown in tunnels using Dutch trellising. For the peppers the 1<sup>st</sup> flowers and branches are pruned to promote lateral growth.

Interestingly, at the end of the growing season (June), all growers from this Moshav, south to the Red Sea clean up their farms (all green matter) to break the pest/disease cycle.

***Tour Participant Comments:***

*The use of bore water with 3.5 EC is very interesting. We have been told in Australia that it is not possible! This Research Station has been working to get the balance of water right and appeared to get very high yields (even though the plants were stunted). Very interesting to listen to their analysis.*

*Kibbutz Yoteva and Moshav Ein Tamer – all very interesting but not much I could personally use, except to keep out the rain.*

*Good to see the farmers are cleaning up all the green matter to break the pest/disease cycle.*

## Day 6 Sightseeing in Jerusalem.

### Day 7, Visit 1, Potato Farm at an Agriculture High School at Magal. Eli Vered. Netafim Market Development Manager Australia and NZ.



Potato Farm: Potatoes grown in two major regions 1. the Negev and 2. Magal region. Two varieties, Netherlands and Israeli. Most are grown with sprinklers, 2 years ago some changed to drip. Using drip has shown a 30% savings in (bore) water. Using sprinklers 20 inches of water is used to grow the potato crop, 15 inches or less with drip. Average is 5 mm per day with sprinklers, 4 mm water per day with drip irrigation – which in Eli's view is still too much. It is hard for growers to lower this level – a change of mind set is required and this can be hard to obtain. It may take up to 3 seasons to convince the grower that less water will grow the same yield.

The crop has been sprayed once for phytophthora with drip irrigation, for the same problem in sprinkler irrigated potatoes the average is 7 sprays per season.

Two systems used for harvest: 1. burn off growth, and 2. slash above ground growth.

As the growers using drip irrigation, irrigate every day via separate sub mains, bays can be switched off for harvesting without effecting the rest of the crop.

Yield is normally 28 tonnes per acre which equates to approximately 70 plus tones per hectare using 5 megalitres per year. Under drip irrigation yield 32 to 36 tonnes per acre using 4 megalitres per year.

The dripper is buried 5 cm below the soil surface, some farmers remove the irrigation tape before harvesting, others after.

The plant stolon must be short to get good sized tubers – most tubers are quite close to the drip line as the roots don't have to go far to find water. Spacing between emitters is 0.3m, 0.4m in heavier soils.

In South Australia's South East, centre pivots apply 10 to 12 mm per day year round, so there are big savings for water if the grower uses drip. Two days after ceasing irrigation with drip irrigation, within 2 days of ceasing irrigation, the potato plants collapse down, ready for harvest.

[Contents Page](#)

[Main CD Homepage](#)

At Keith in SA's SE using saline water (2000ppm), drip irrigation achieved minimal Chloride levels where centre pivots couldn't on the same saline water.

For the spuds at Magal, urea is applied 200 kg N/Ha using fertigation and this is applied once a day. With sprinklers, fertilization must stop prior to flowering. With drip, fertigation stops 2 weeks after flowering, which leads to an earlier harvest and longer shelf life for the produce.

Potatoes are planted at 4 seed to the metre. Most of Israel's potatoes are grown in sandy soils. Bed spacing is 1.2 metres. Yield increases 10 to 15% under drip irrigation. Another advantage of drip irrigation is that if a pest control spray is required (insect or disease), this can be done anytime as the soil is dry. The growers only put water and fertiliser through the drip lines – chemicals are not allowed.

**Day 7, Visit 2, Kibbut, Netafim, Magal. Eli Vered. Netafim Market Development Manager Australia and New Zealand.**



Netafim has 3 factories in Israel, as well as Brazil, USA, India and Australia. 46% of the world's irrigation tape and 70% of the world's drip tube is supplied by Netafim.

Netafim has projects all over the world, but only work directly with AZROM in Australia. The company sells independently in all other countries.

**Netafim Seminar led by Dr Menachim Dinar – initially started research career at Hbsor Research Station, now employed by Netafim.**

Business Opportunities (Greenhouse technology).

- New marketing strategy and business opportunities reflect on the development of the greenhouse section.
- Demand for quality production in various markets worldwide
- Demand for pesticide free crops
- Expectation of high returns
- Technical ability to get good results in various climatic conditions

The latter two points are the main reasons for the increased number of greenhouses. Netafim is usually involved in the agronomy of the project in the 1<sup>st</sup> year of the new greenhouse.

**Cold Climate Greenhouses:** have high structure, with a gutter height of 4 metres, insulated, heated by a hot water system, Rigid covers, ventilation, air circulation.

**Cold Climate Greenhouse**

- High structure, gutter height - 4m
- Insulated, heating by hot water system
- Rigid covers - glass or polycarbonate
- Ventilation - natural or forced for heat & humidity expulsion
- Air circulators & roof vents

**Warm & Tropical Climates**

- Flexible or rigid covering
- Curtained openings in walls & roof - for max. ventilation
- High wind resistance - 150 as standard
- Trellising loads -25 k”g/m2
- Polyethylene attached with aluminum or wood profiles
- Structural components galvanized after welding & punching operations



**Grower Considerations – main parameters**

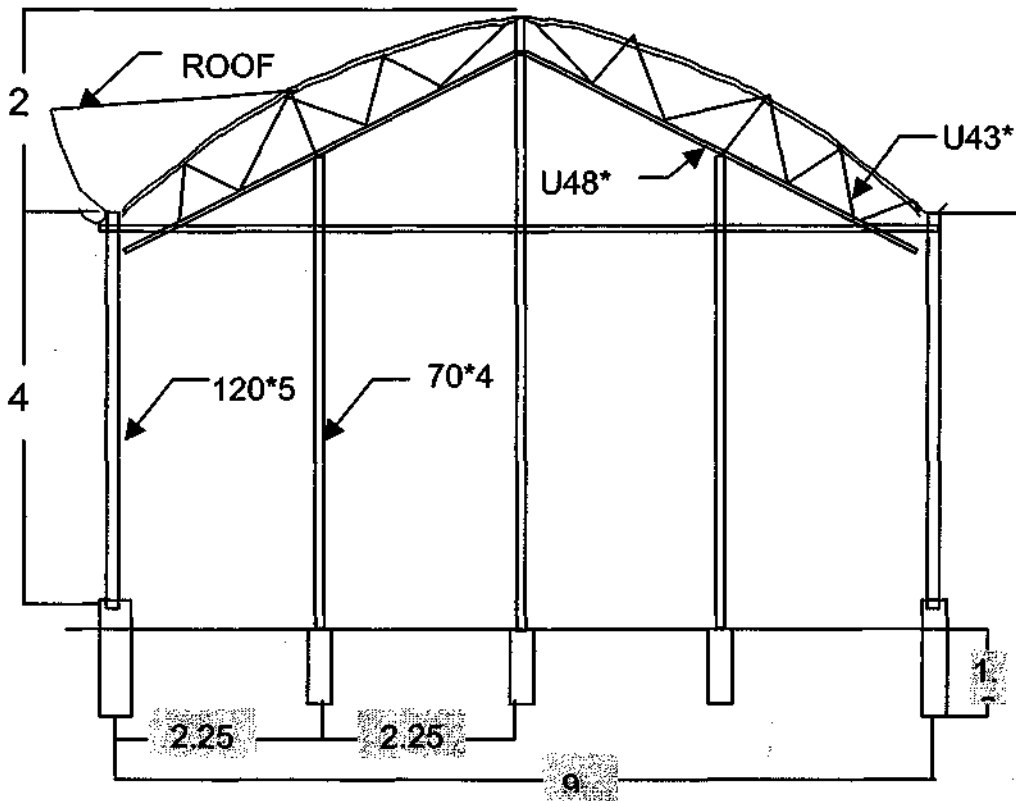

**Second type: Negev Model**

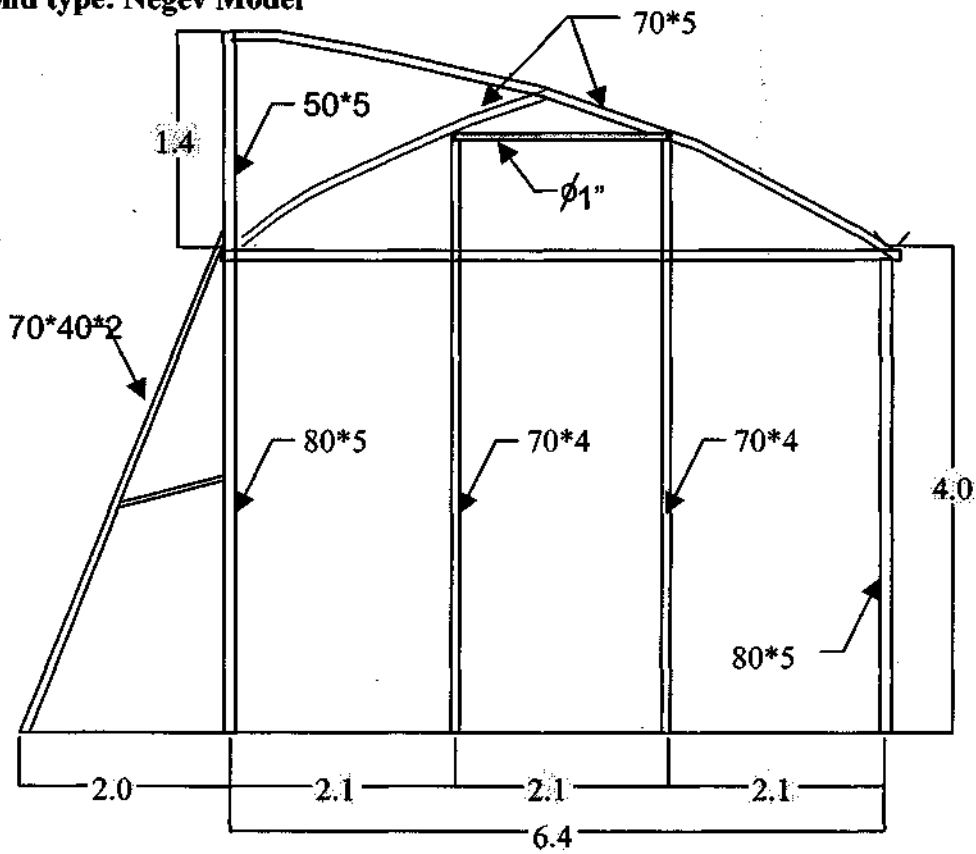

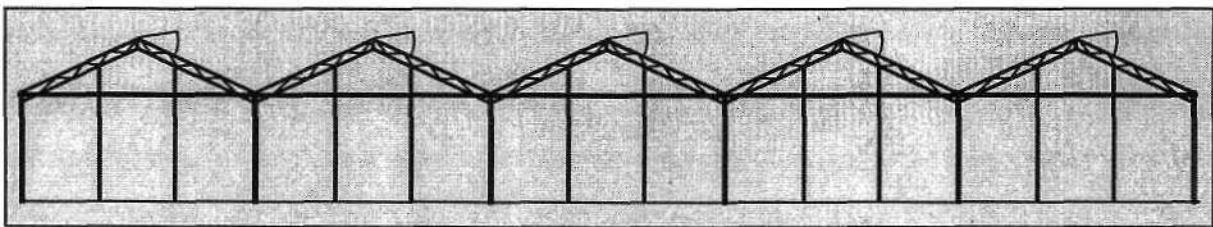
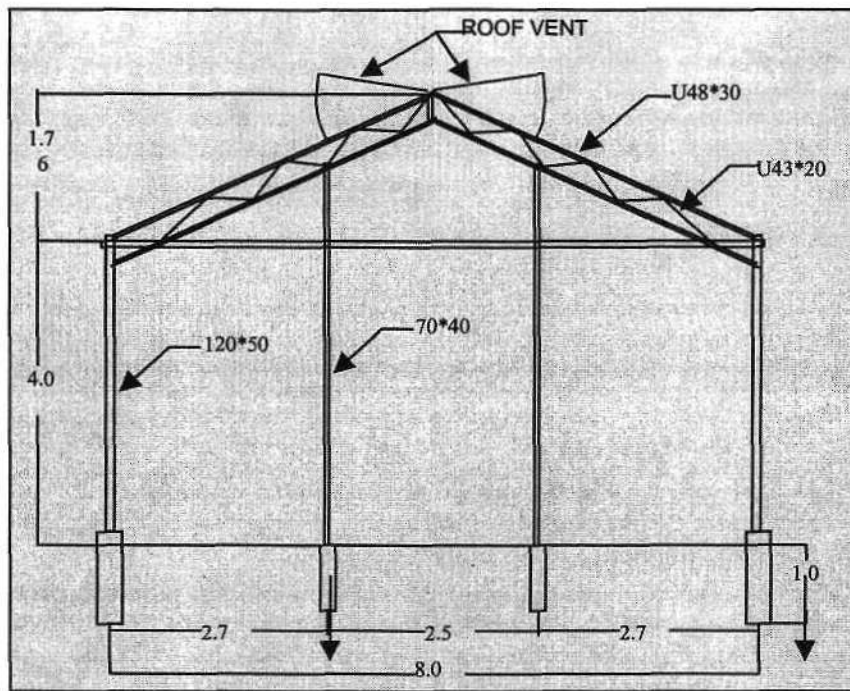

**Covers: (Very important) Essential anti-fog properties**

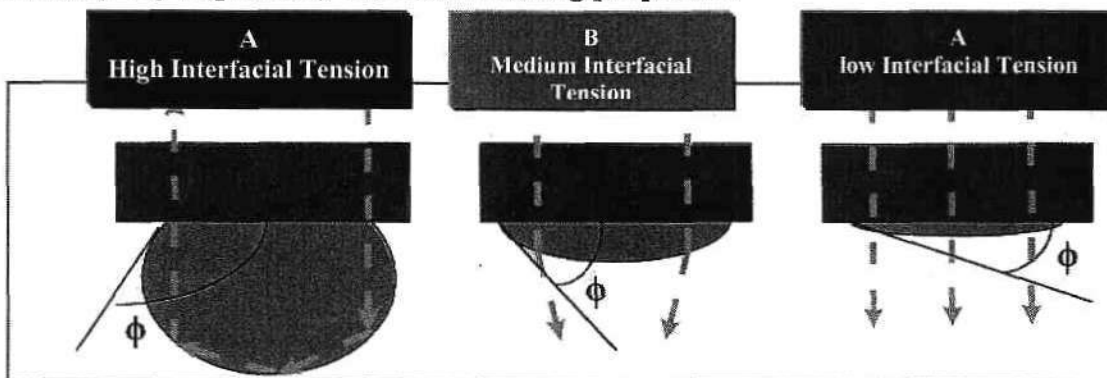

- high light transference for photosynthesis (0.4 – 0.7 )
- diffused light enhances photosynthesis process in lower parts of the plant
- Adaptable to specific spectrum penetration needs.

(diffused light – scatters light so better penetration to the lower part of the plant)

For Peppers it is better to have diffused light, for tomatoes, a reduction in total light can be disastrous, therefore direct light is better.

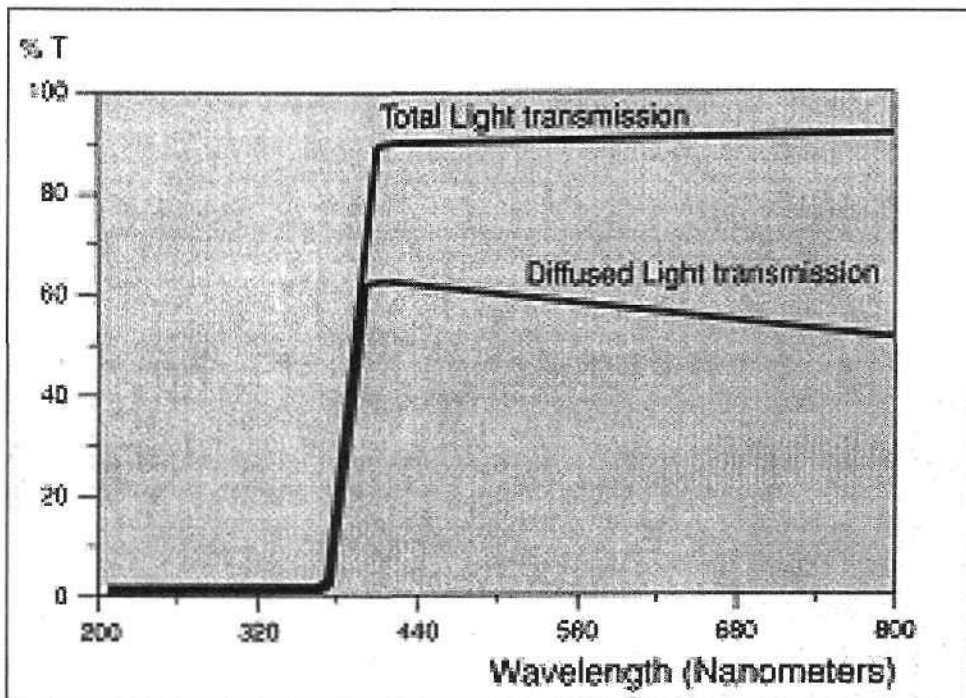

**Greenhouse Microclimate:**

- Polyethylene cover coated with anti-fog to prevent dripping
- Additives in polyethylene absorb IR light & prevent long-wave radiation escape.

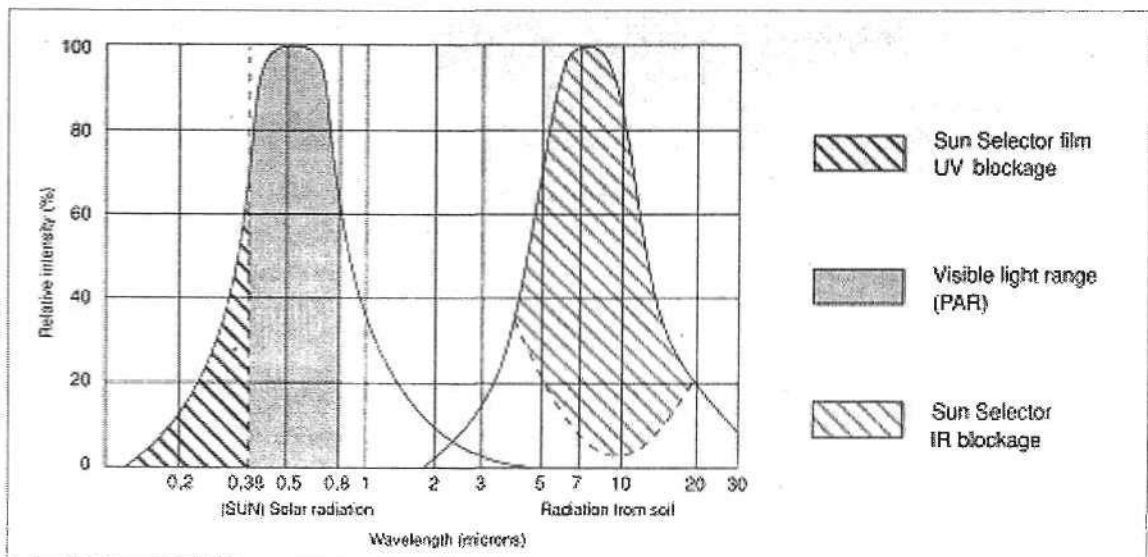



### Strength, deterioration, diseases and pests

- Polyethylene covers will last 2-3 growing seasons.
- Additives in cover can prevent damage to plant from UVA radiation
- Can prevent outbreak of disease (botrytis, peronospora).
- Additive can block light spectrum penetration up to 0.39 microns & prevent white fly infestation.

### Light Spectrum.

Roses can have pigmentation differences in different infrared spectrum.

### Insects: UV Block

Same variety, same planting date – only difference was use of UV plastic. Virus attacked much less (almost 0%) under UV plastic. Effects navigation of Bemisia (whitefly) due to blocked spectrum (needed by Bemisia). Could also effect bumble bees – however, Biobees navigation has proved little effected by the UV plastic.

### Cooling

#### Heat and Heat expulsion:

- Air flow through side wall & roof opening
- Hot air inside replaced with cooler air from outside
- Hot air exits via roof vents, whilst cold air enters
- Air flow serves to expel excess humidity

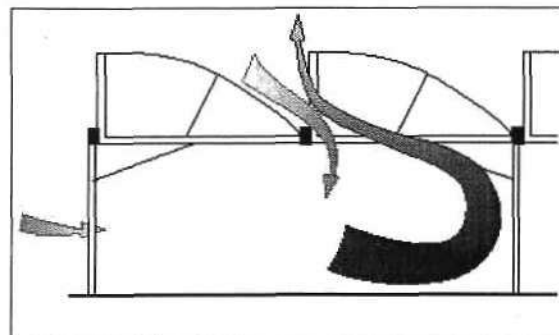
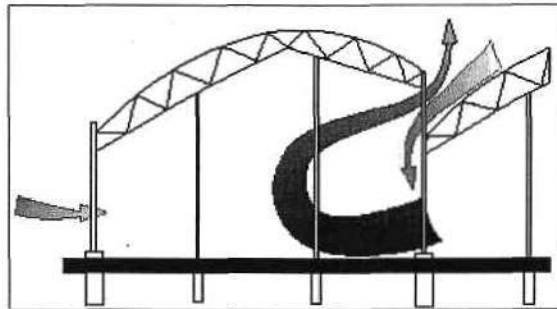
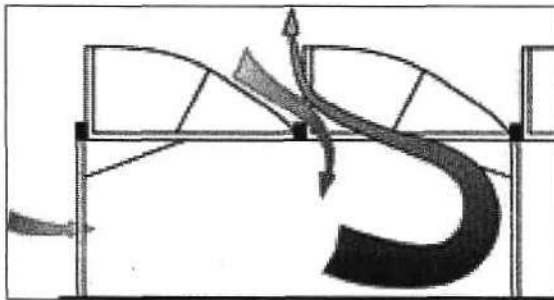

### **Forced Ventilation: (expensive system)**

- Used when fresh airflow insufficient for plants needs or when using pad & fan system
- Based on negative lengthwise ventilation

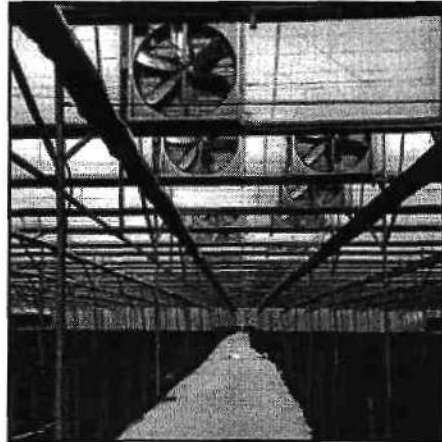
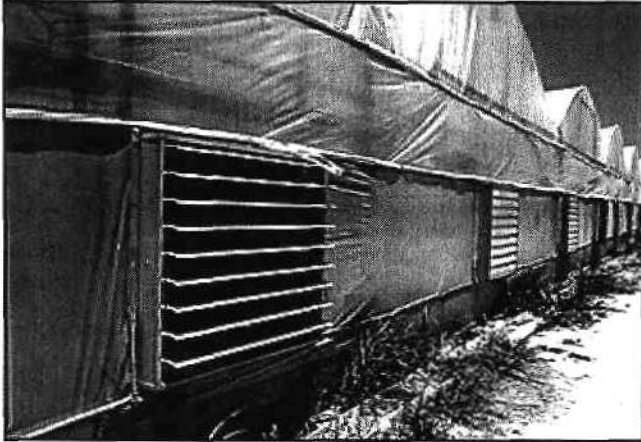

Not many Israeli growers use this as it is too expensive.

### **Shading:**

- One screen allows for some radiation to penetrate & some to be reflected.
- Another type prevents some long-wave radiation from greenhouse resulting in energy conservation.
- Reflective thermal screen decreases heat loads & prevents energy loss.
- Screen operations automatically controlled according to light intensity & desired internal temperature.

It is possible however, to make too much shade and reduce yield so the shade must be controlled properly – i.e. relationship between light and temperature must be understood.

Colour of the shadecloth can have a big effect on growth. Blue has a negative effect and red can have a very positive effect with the same percentage of shade. Why? The shadecloth colour can effect length of internodes which need certain parts of the light spectrum.

### **Phytomonitoring:**

**Plant status:** 1. Leaf temperature

2. Stem diameter

3. Fruit diameter

4. Water flux

•**Climate condition:** 1. Air temperature

2. Air humidity

3. Radiation

•

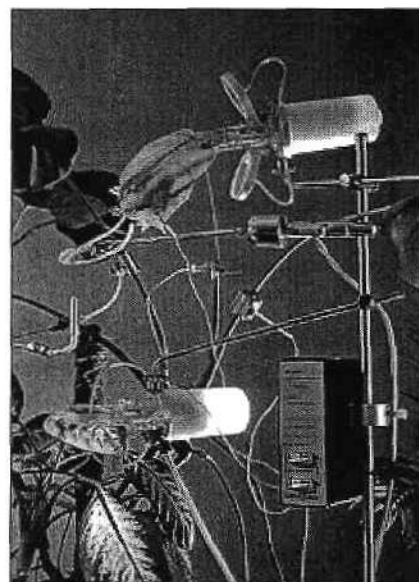

**Soil Moisture:** Water Status in the substrate

This system will not solve all growers problems – it is just another tool to help understand growth requirements.

Stem Increments: Stem growth fluctuates day/night – it is not linear.

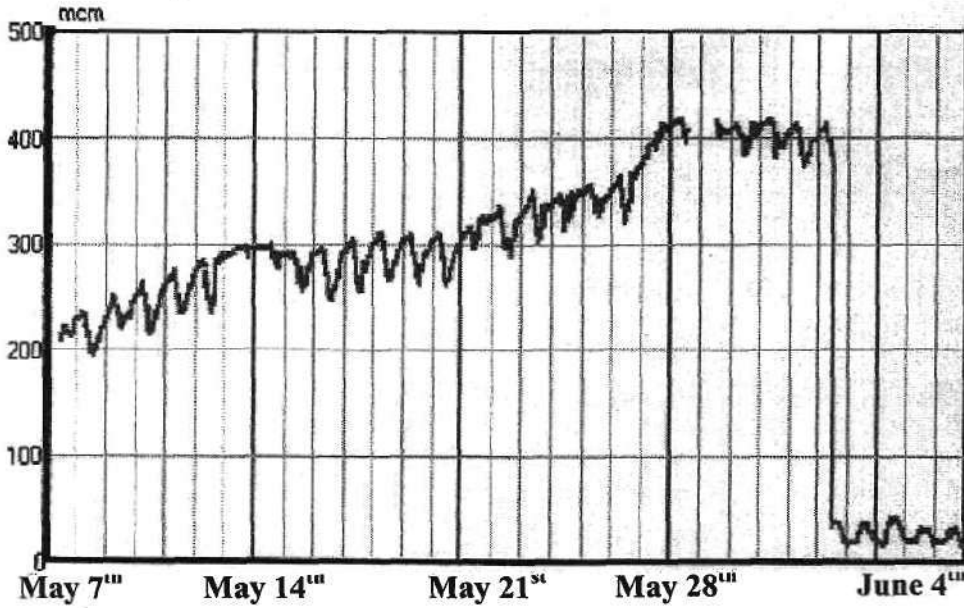

This system could also have applications for outside crops.

**Optimal Plant Environment:**

Inputs:

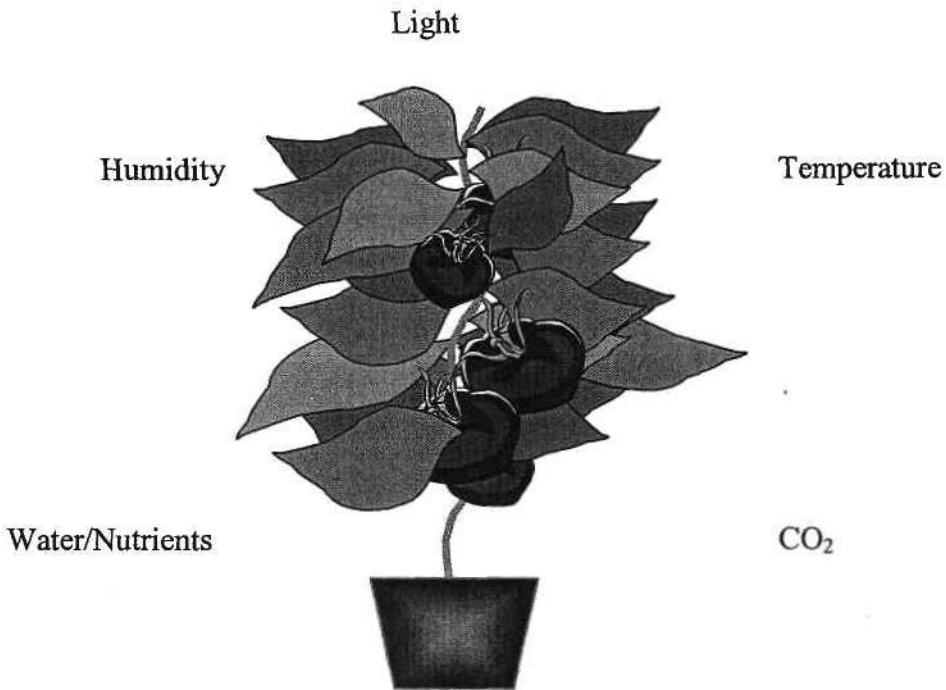

Pepper with an increase in CO<sub>2</sub> shows a 25% increase as do Strawberries and the sugar levels are much better. Netafim will be looking at the increase of CO<sub>2</sub> in other greenhouse crops in the future

Boris Stoeff asked the difference between polycarbonate, polyethylene and glass.

Main difference is that glass is expensive, much more expensive than polyethylene, it transmits light better, keep temperature better inside the structure, heavier, very difficult to ventilate glasshouse compared with polyethylene.

Polycarbonate, both 1 and 2 layers.

2 layers is very good for cold climates, helps make lighter structures (than glass), light penetration much lower than required.

1 layer is very good, very strong, penetration of light is good, Infra red is OK and antifog abilities OK, price is a disadvantage, and can have UV blockers in polycarbonate.

If you compare the price over 10 years, investment is initially higher than polyethylene, but after 10 years it is comparable.

Many growers in Israel, use 'Insect proof' greenhouses – covered hermetically by insect proof net (almost a greenhouse).

Insect proof nets have a life span of 4 to 5 years, and does provide some level of shade and increases humidity. The increased humidity can be seen as a disadvantage, as can dust clogging the insect proof netting.

Menachim suggests shade provided by the insect proof netting may be as high as 50%.

#### **Netafim R&D Station: Magal Kibbutz**

Netafim experiment with all different types of greenhouses (in all weather types), including Polyhouses (AZROM), other polycarbonate structures, tunnels and structures with opening and closing roofs etc.

Drippers, both surface and sub surface (different experiments) – “We intend to supply water to the plants requirements – not what we think it needs”

The aim is to know how much and when the plant needs the water and fill the requirement.

If there is water stress, the first noticeable change to the plant is to the leaves. Leaves are heavier when they have water, and a sensor can be used to check cell thickness in the leaves. Studies to this point have illustrated that most producers irrigate too much. Initial estimates have indicated that growers can save 30% in water costs and at the same time show a yield increase of 20% by watering to the plants needs.

If the grower supplies water exactly when a plant requires it, it is easier for the plant to find it, therefore yield increases.

Research at Netafim has found that “low-flow” irrigation causes blossom end rot in tomatoes.

The time it takes for water to pass from the wet to the dry zone near the plant roots can be too fast, so low flow irrigation is used which uses much less water over a longer time frame. This can be up to 26 water applications a day, which leads to better water uptake by the plant.

[Contents Page](#)

[Main CD Homepage](#)



Netafim experiments have shown that using this system they can get three times as much fruit on an eggplant than expected for this region.

**Family System (Primarily for low income, third world countries)**

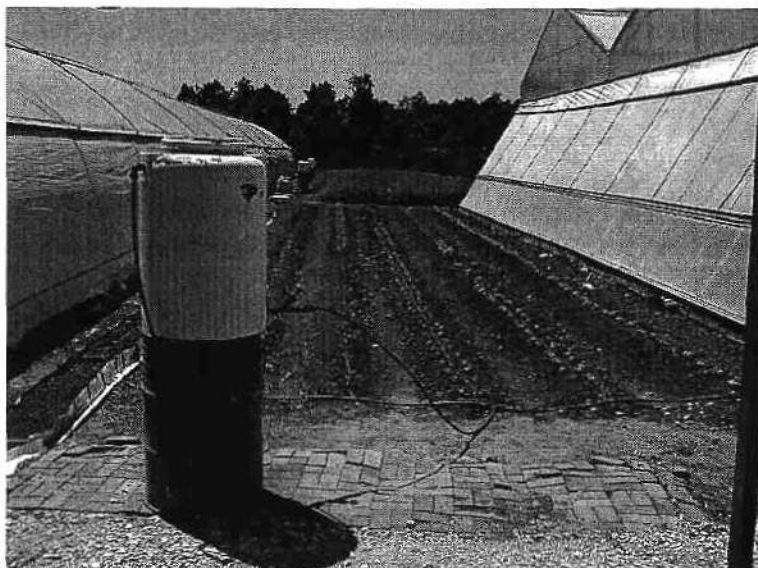

The Family System uses 1 metre head pressure (44 gallon drum height), and 3 litre per hour flow rates. The system has simple instructions for watering and fertilizing. Netafim are experimenting using low flow rates for this system as well. This system is ideal for areas that have little water and no power.

For example, to produce rice using the 'normal' growing method requires a total of 3 litres of water, using the family system this is reduced to 1 litre for the same yield.

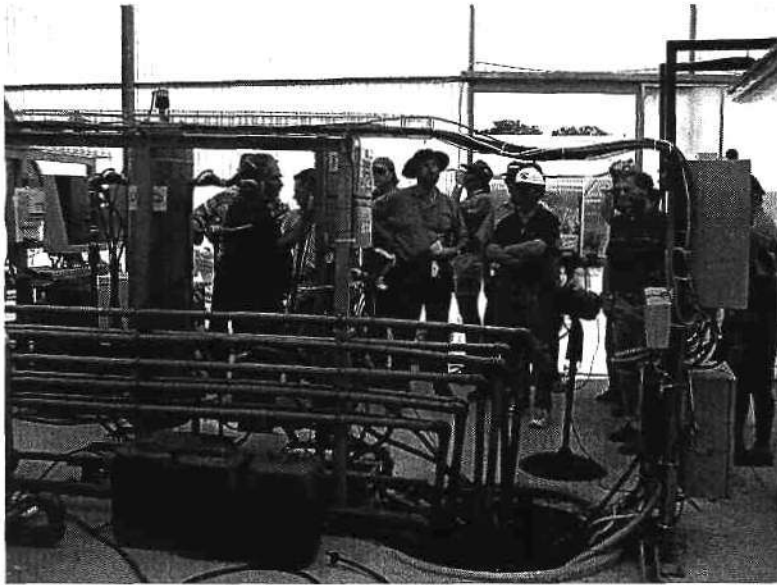

Netafim is also experimenting using a recycled water system to grow tomatoes on a hydroponic system. This system uses 30% runoff from the hydroponic setup, the runoff water is filtered and UV treated and has resulted in huge crops. For the variety used a high EC is good for sweetness.

The recycling system is gravitational, and feeds into 2 underground tanks. When a tank is full, it gives a pulse to the system using a cheap sensor, sent to the filter, UV treatment and then sent to a holding/mix tank. If the EC is higher than required, less fertiliser is used. Each greenhouse can be run on a separate recycling system fed through 1 filter/UV treatment system.



Hydroponic Flowers: 2 media are being trialled, cocoanut (which as a media can lower the pH of the water) and Rockwool. For vegetables volcanic stone (scoria) has proven the best.

*Tour Participant Comments:*

*Potatoes: - interesting but too costly for Australian conditions and market prices*

*Netafim Products: - ready market in Australia*

*Netafim Family System: - simple and a good idea for home gardeners in Australia – a definite market here. Bill Elliott has seen similar systems used commercially for strawberries in Australia.*

*With all the wonderful equipment we saw on offer, one must be careful not to over capitalize in Australia.*

## **Contacts:**

### **NETAFIM:**

Eli Vered, Market Development Manager, Australia & New Zealand  
Kibbutz Magal D.N. Hefer 38845, Israel  
Email [eliv@netafim-magal.co.il](mailto:eliv@netafim-magal.co.il)

Arie Eyal, State Sales Manager, SA,  
258 Payneham Road, Payneham, SA, 5070  
PO Box 322, Marden, SA, 5070  
Phone (08) 8363 9311, Fax (08) 8363 9322  
Email [aeyal@netafim.com.au](mailto:aeyal@netafim.com.au)

### **AZROM:**

Ilan Kanety, Australian Marketing Manager  
4 Ezra Street, Rehovot 76200, Israel  
Phone (02) 6968 3312, Fax (02) 6968 3313, Mobile 0419 618 377  
Email [azrom@azrom.co.il](mailto:azrom@azrom.co.il)

### **ELDAR SHANY:**

Joseph (Yossi) Livne, Application Engineer,  
Yad Mordechai, 79145, Israel  
Email [livne@eldarshany.com](mailto:livne@eldarshany.com)



## **Acknowledgements**

Rob Kennedy and Craig Feutrill would like to acknowledge and thank the following people and Corporations for their assistance in organizing, running and supporting the Greenhouse Tour to Israel.

First and foremost to the grower delegates, who not only made the tour enjoyable, but also contributed greatly to the report and subsequent meetings.

To the Horticultural Research & Development Corporation for providing part-funding under the Voluntary Contribution process that allowed the growers to attend this tour. Particular thanks goes to Jonathan Eccles of the corporation for his insight, leadership and assistance in preparation of the proposal.

To the AZROM staff who assisted us in organizing the tour before we left and whilst in Israel – particularly Ilan Kanety, the Australian Marketing Manager.

To the Netafim staff, who pulled out all stops to ensure we had a trouble free run whilst in Israel – particular thanks go to Arie Eyal, State Sales Manager for SA, Eli Vered, Market Development Manager for Australia and New Zealand and Peter Anderson, State Sales Manager for Queensland. Peter was not only a fount of knowledge on irrigation and all aspects of Greenhouse production, but a superb tour guide on the history of Israel, Biblical times and war history – including the last charge of the Light Horse Brigade at Beer Sheeba.

## Tour Participants

	<b>NAME</b>	<b>POSTAL</b>	<b>Ph/Fax</b>	<b>CROP</b>
1	<b>Craig Feutrill</b>	Vegetable industry IDO S A Farmers Federation 122 Frome street Adelaide SA 5001	M 0418 831 089	Industry Development Officer
2	<b>Phung Phuong Duy</b>	7 George Street, Pennington SA 5013	M 0418 829 333 A/H 8380 9710	Green house veg
3	<b>Phan Ngoc Tri</b>	18 Wilson Street, Mansfield Park SA 5120	WORK 8380 9878 M 0419 814 129	Green house veg
4	<b>Tu Giang</b>	6 Acacia Street Kilkenny SA	04178 79062 P 83454957	Green house veg
5	<b>Het Truong</b>	69 Hooking Tee Woodville Gdns SA 5012	0412 518 527	Green house veg
6	<b>Bill Elliott</b>	267 Bartlett's Lane Meerschaum Vale Via Alstonville NSW 2477	02 6683 4207 ph/fax	Greenhouse Veg
7	<b>Bill Schouten</b>	Hestron Pty Ltd M.S. 305 Sheehans Road Bundaberg Qld 4670.	Ph 07 4159 6344 Fax 07 4159 6110	Veg hydro tomato green house
8	<b>Boris Stoeff</b>	B & M STOEFF Glasshouse Supplies Odgers Road Virginia SA 5120	8380 9078 Fax 8380 9554 0411 872 481	Green house veg
9	<b>Rick Sutton</b>	Mt Sylvia Road M/S 149 Tenthill Via Gatton 4343	P 0754 627 129 F 0754 627 322 0419 757 619	Green house veg
10	<b>Murray Sturgess</b>	Evandene M.S.355 Chinchilla QLD 4413	P/F 0746 657 564	Lettuce

11	<b>Dennis Dickman</b>	BAR-K FARMING Pty Ltd 88 Wambo Street Chinchilla QLD 4413	P 07 46627906 0428 717 104	Water melons
12	<b>Darryl O'Leary</b>	M.S 355	P/Fax 07 4665	Water
13	<b>Janet O' Leary</b>	Chinchilla Qld 4413	7563	melons
14	<b>Peter McIntosh</b>	Mc Intosh Farms Pty Ltd M.S. 464 Carpendale Via Helidon Carpendale Qld.4344	P 07 469 76205 F 07 469 76224 M 0415 716 778	Water melons
15	<b>Ian Beard</b>	I.L. & S.F. Beard "Redford" MS 355, Chinchilla, QLD 4413	0427 700186 F 07 466 57582 P 07 4665 7524	Water melons
16	<b>Jeffery Leonard Skuse</b>	317 Whites Road Paralowie	P/F 8258 7398 (home)	
17	<b>Bradley Thomas Skuse</b>		8284 9113 (garden)	
18	<b>Ray Fulcher</b>	R & K E Fulcher M.S. 963 Wisers Road Bundaberg Qld 4070	0418 798 294 P0741 597 107 F 0741 597 192	
19	<b>Roberto Barbera</b>	Lot 8 Douglas Road Bundaberg QLD 4070	P 0741597663	
20	<b>Eddy Zaina</b>	M.S. 963 Mahogany Creek Road Bundaberg QLD 4070	P 0741597528	
21	<b>Robert Kennedy</b>	Virginia Horticulture Centre PO Box 847 Virginia SA 5120	0414983807	
22	<b>Hartley Lewis</b>	Lewis Landscaping & Nurseries PO Box 798 Virginia SA 5120	AH 8380 9926 Ph 8380 9598 F 8380 9774	
24	<b>David D'Alberto</b> Joining from Holland			